

Product Specification

Neon Flex Horizontal Bending Single Color Series (Type TA)

WW-FLS102T23XX140TA-24(WCP)-XR-SE-V-040-XX



HK Office :

Unit 1901, 19th Floor, NanYang Plaza, No. 57 Hung To Road
Kwun Tong, Kowloon, Hong Kong

China Factory :

Zhiyang Science and Technology Park, 10 Zhiyang Road, Zhangge,
Fucheng Street, Longhua District, Shenzhen, Guangdong, China

Tel : (852) 3152 3059 (10 lines)

Fax : (852) 3152 3039



Tel : (86) 755 8601 9190



Fax : (86) 755 8601 9197

Product Features

- High quality FPC
- Dilux self-encapsulated LED
- Light source lifetime:50K hours
- Horizontal bending
- High quality silicone material
- IP65 waterproof
- Min.Bending Diameter:Φ60mm
- Single-ended power supply maximum length: 6m

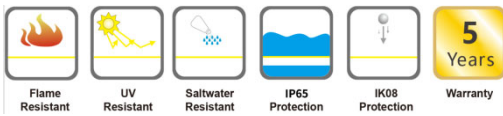

Technology info

- Lighting Technology: LED
- DLS or NDLS: NDLS
- MLS or NMLS: NMLS
- Type of light source: SMD2835
- Energy consumption KW/1000h/0.5M:5.2
- Beam angle : 120°
- Survival factor (Annex V/EU2019-2020) :90%

Harmonised Standards

EMC

- EN55015:2013+A1
- EN61547:2009
- EN60598-1:2015
- EN60598-2-20:2015
- EN62493:2015
- EN62471:2008

Parameters

Test condition:

- Surrounding temperature: 26°C.
- Test while turning on.

Neon Flex									
Neon Flex Model No.	CRI (Ra)	Rf	Rg	Typ. Power (W/M)	Max. Power (W/M)	Color	Neon Flex Color Temp.(K) Wavelength(nm)	Typ. Luminous Flux LM/M(39.37in)	Rated voltage
WW-FLS102T23WW140TA-24(WCP)-HR-SE-V-040-XX	≥80	82	96	9.6	10.5	Warm White	2500K	340	DC24V
WW-FLS102T23WW140TA-24(WCP)-HR-SE-V-040-XX						Warm White	2700K	340	DC24V
WW-FLS102T23WW140TA-24(WCP)-HR-SE-V-040-XX						Warm White	3000K	350	DC24V
WW-FLS102T23NW140TA-24(WCP)-HR-SE-V-040-XX						Natural White	4000K	360	DC24V
WW-FLS102T23SW140TA-24(WCP)-HR-SE-V-040-XX						Standard White	6000K	360	DC24V
WW-FLS102T23WW140TA-24(WCP)-UR-SE-V-040-XX	≥90	90	100	9.6	10.5	Warm White	2500K	270	DC24V
WW-FLS102T23WW140TA-24(WCP)-UR-SE-V-040-XX						Warm White	2700K	270	DC24V
WW-FLS102T23WW140TA-24(WCP)-UR-SE-V-040-XX						Warm White	3000K	290	DC24V
WW-FLS102T23NW140TA-24(WCP)-UR-SE-V-040-XX						Natural White	4000K	290	DC24V
WW-FLS102T23SW140TA-24(WCP)-UR-SE-V-040-XX						Standard White	6000K	290	DC24V
WW-FLS102T23SR140TA-24(WCP) -SE-V-040-XX	/	/	/	9.6	10.5	Red	620-630nm	60	DC24V
WW-FLS102T23SG140TA-24(WCP) -SE-V-040-XX						Green	515-525nm	340	DC24V
WW-FLS102T23SB140TA-24(WCP) -SE-V-040-XX						Blue	465-475nm	60	DC24V
WW-FLS102T23AY140TA-24(WCP) -SE-V-040-XX						Yellow	585-595nm	60	DC24V

- SDCM for light source: ≤6 (alternative ≤3).
- The typ. Luminous flux tolerance range is ±10% (subject to the manufacturer's instrument test).

Optical Test Diagram

Neon Flex

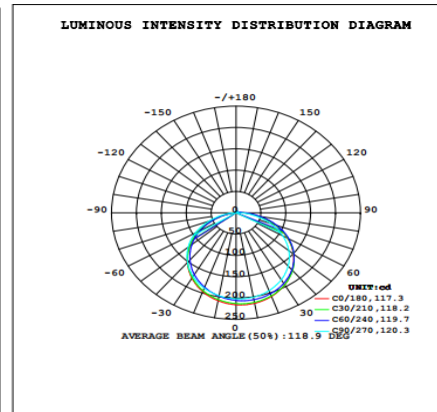
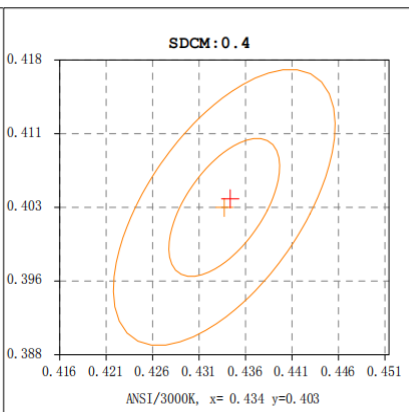
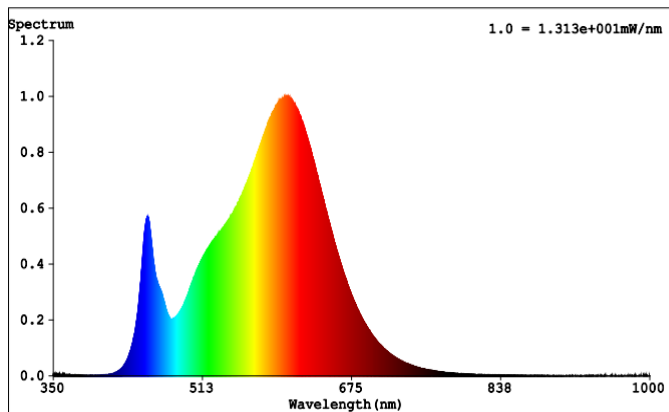

Circuit Diagram

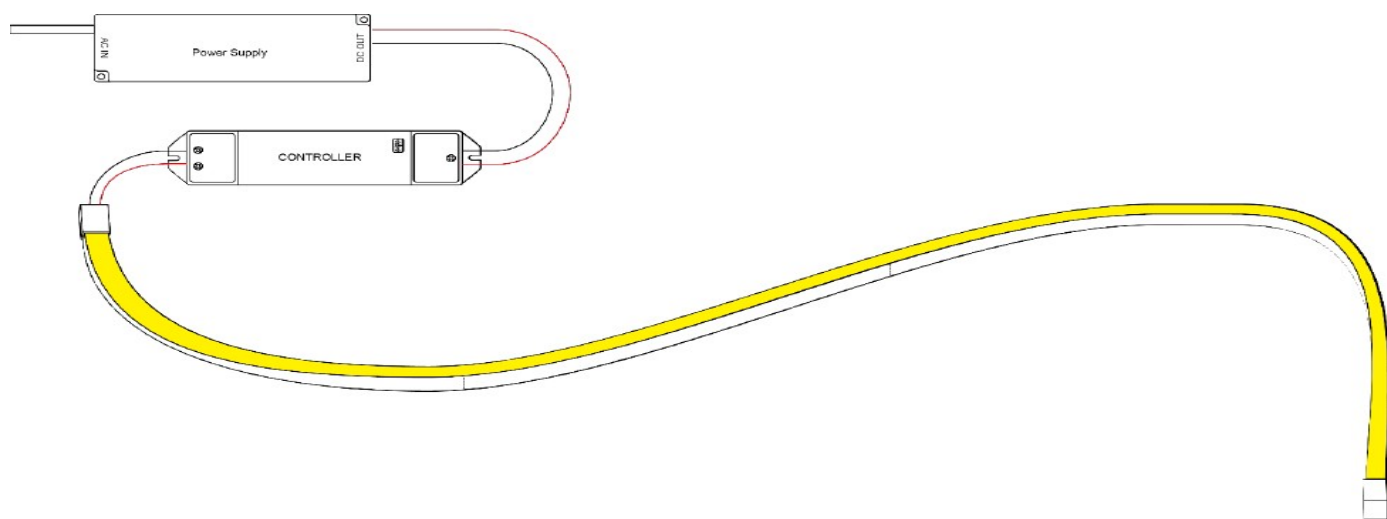

Dimension Drawing

Neon Flex

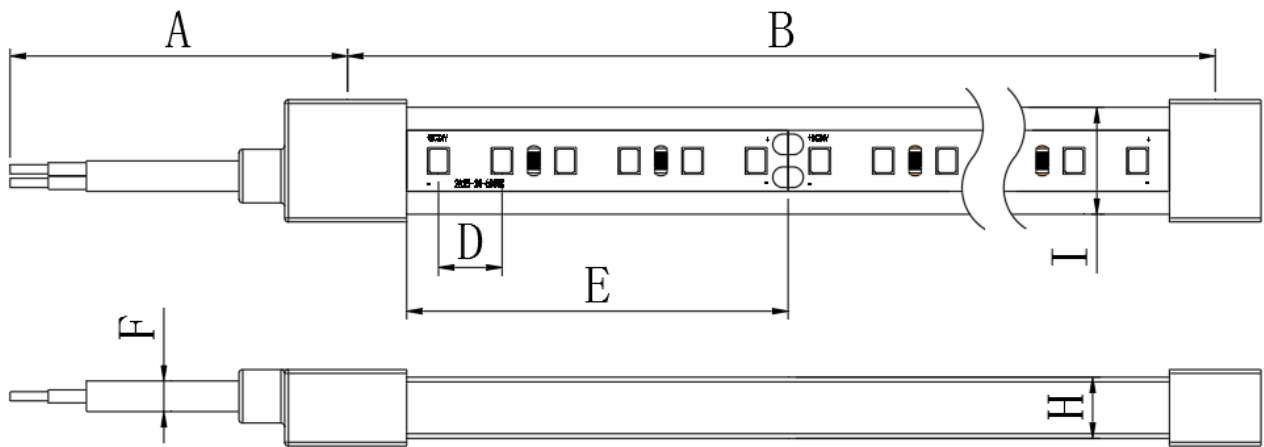

A	B	D	E	F	H	I
Cable Length	Strip length	Distance of LEDs	Cutting unit	Cable diameter	Strip thickness	Strip width
300±10mm	5000±50mm	7.14±0.2mm	50±0.2mm	6.0±0.2mm	4±0.3mm	8±0.5mm

Front & end caps

Cable Types	Model No.	Image	Dimension	IP Rating
Same Width	TA4X8-TT2			IP65
Side cable	TA4X8-TC			IP65
Bottom cable	TA4X8-TD			IP65

Optical Parameters

Distribution Curve Flux

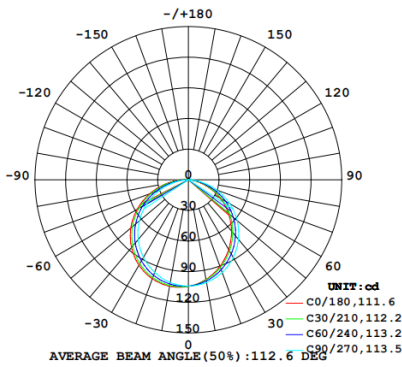

Illuminance

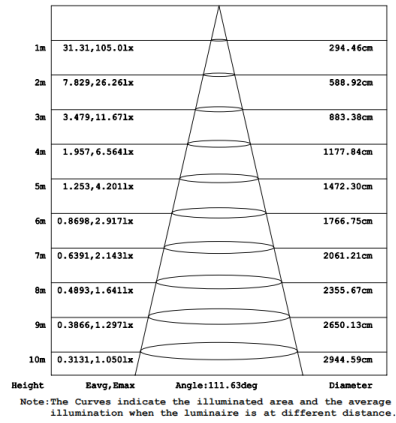

Figures of typical characteristics

Relation of Working Temperature and Power

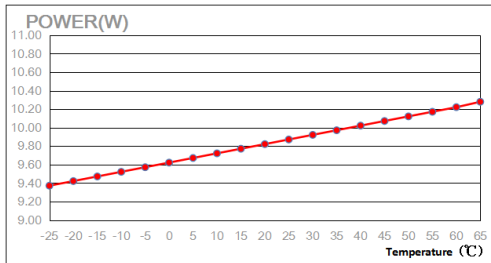

Relation of luminous flux and strip length (Only suitable for white series)

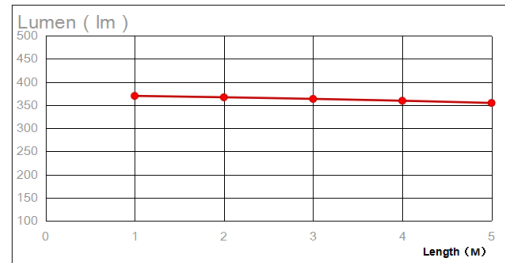



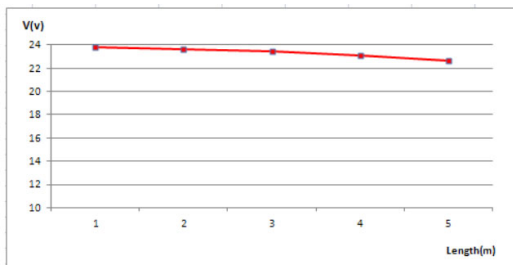

Relation of operating voltage and strip length



Standard Accessories

Image	Part No.	Description
	WW-PC1006-0025	Installation accessories set (PC mounting clips, screws)

Optional Accessories

Image	Part No.	Description
	WW-AP1006-200	Aluminum Profile: L2000*W5.6*H9.6mm
	WW-LG0510-500	TA-type 4mm moldable profile
	WW-FLS102TA-CW(4mm)-TT2	Cutting accessories set (Front & end cap, power cord)
	WW-FLS102TA-CW(4mm)-TC	Cutting accessories set (Front & end cap, power cord)
	WW-FLS102TA-CW(4mm)-TD	Cutting accessories set (Front & end cap, power cord)

Packaging

**Solution 1:
For Product Length=5M**

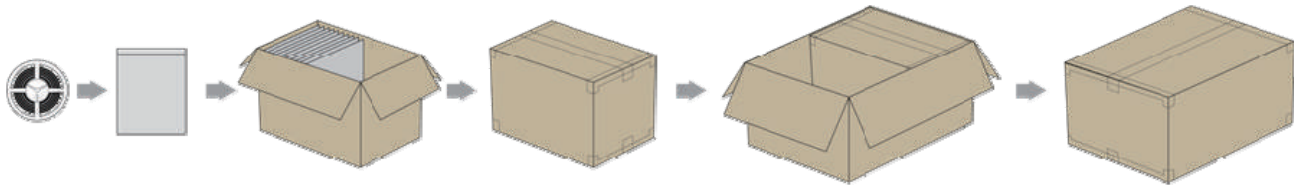

Ingress protection rating	Bag size	Inner carton		Outer carton		N.W	G.W	Outer carton volume
		Size	Reel/ctn	Size	Reel/ctn			
IP65	250*280*0.14mm	380*210*240mm	20	440*400*260mm	40	9.8KG ±10%	12.49KG ±10%	0.04576m³
	9.84*11.02*0.006 in	14.96*8.27*9.45 in	20	17.32*15.748 *10.236 in	40	21.60 Lbs ±10%	27.54 Lbs ±10%	1.616ft³

For Product Length=10M

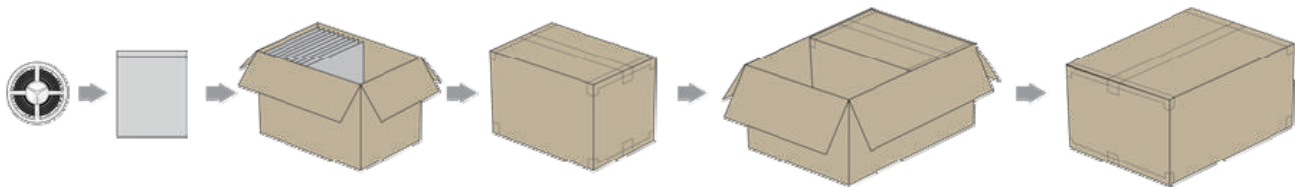

Ingress protection rating	Bag size	Inner carton		Outer carton		N.W	G.W	Outer carton volume
		Size	Reel/ctn	Size	Reel/ctn			
IP65	350*380*0.14mm	330*200*330mm	6	420*350*365mm	12	5.88KG ±10%	7.49KG ±10%	0.0537m³
	13.78*14.96*0.006 in	12.99*7.87*12.99 in	6	16.54*13.78 *14.37 in	12	12.96 Lbs ±10%	16.52 Lbs ±10%	1.898ft³

**Solution 2:
For Product Length=20M**

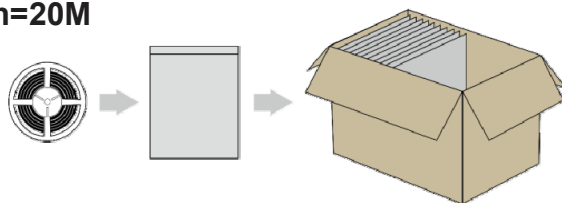

Ingress protection rating	Bag size	Inner carton		Outer carton		N.W	G.W	Outer carton volume
		Size	Reel/ctn	Size	Reel/ctn			
IP65	470*440*0.14mm	/	/	440*400*260mm	15	14.7KG ±10%	18.72KG ±10%	0.05772m³
	18.5*17.32*0.006 in	/	/	17.32*15.75 *10.24 in	15	32.4Lbs ±10%	41.27 Lbs ±10%	1.616ft³

Remarks :

- Please contact our sales manager for customized package (color box, blister etc.)

Cutting Instruction

- The cutting line logo on the Neon strip marked by calculated dimension, it has a little bit deviation between internal cutting line marked on the PCB surface;
- Please follow the cutting guidance as below:
Step 1: Fine the cutting line on the silicone coating, slice the silicone coating vertically by knife along the cutting line, but do not hurt the PCB inside.



- Step 2: Split the broken silicone coating and observe the deviation between "Cutting line on the PCB" and "Cutting line on the silicone coating side"



- Step 3: Find the cutting line on the PCB, adjust to the exact cutting location and slice the silicone coating again.



- Step 4: Finally, use scissor to separate the Neon Flex along the cutting line on the PCB.

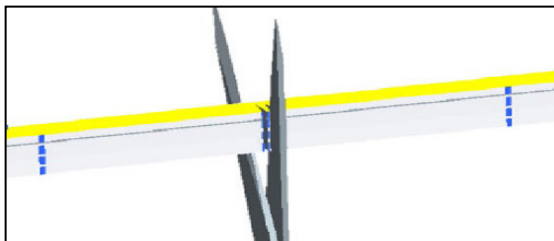

Installation Guidance

1. Do not bend smaller than allowed minimum bending diameter

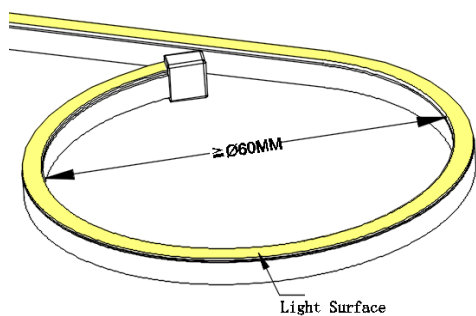

2. The neon strip can only be bent laterally (Along the FPC inside).

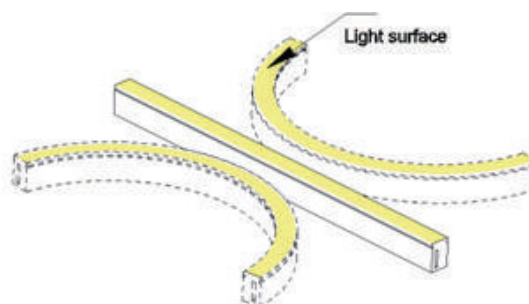

3. Don't bend the LED strip vertically, it will damage the circuit inside and cause product function failure.

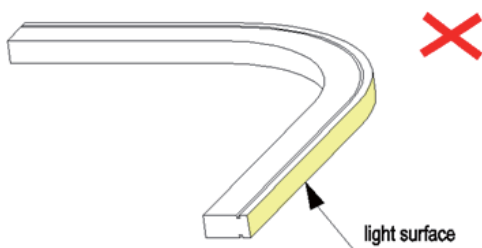

4. Don't twist the LED strip, it will damage the circuit inside and cause product function failure.

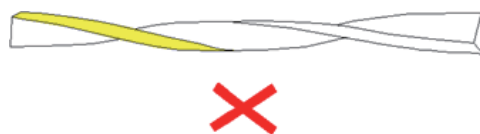

5. Do not hang or suspend the Neon strip in the air.

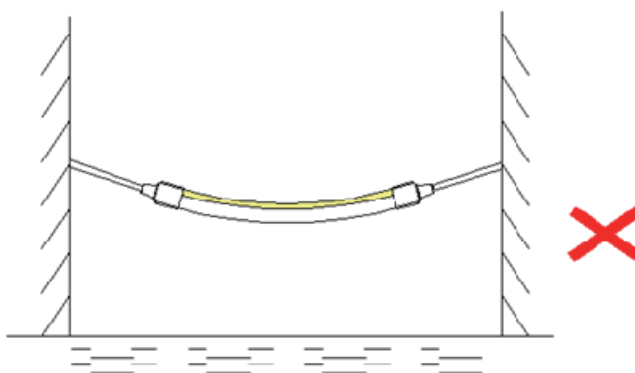
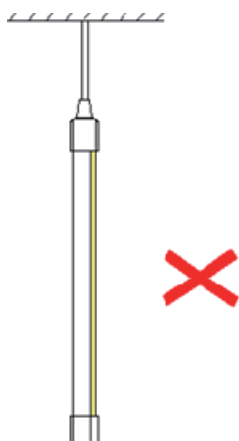



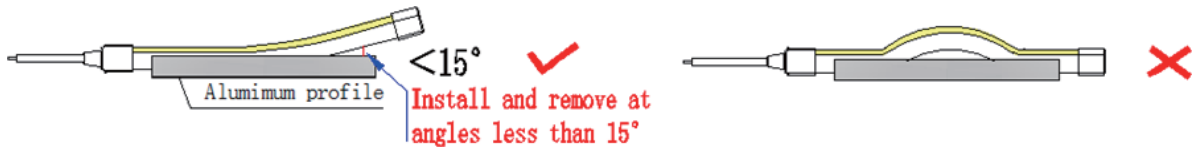



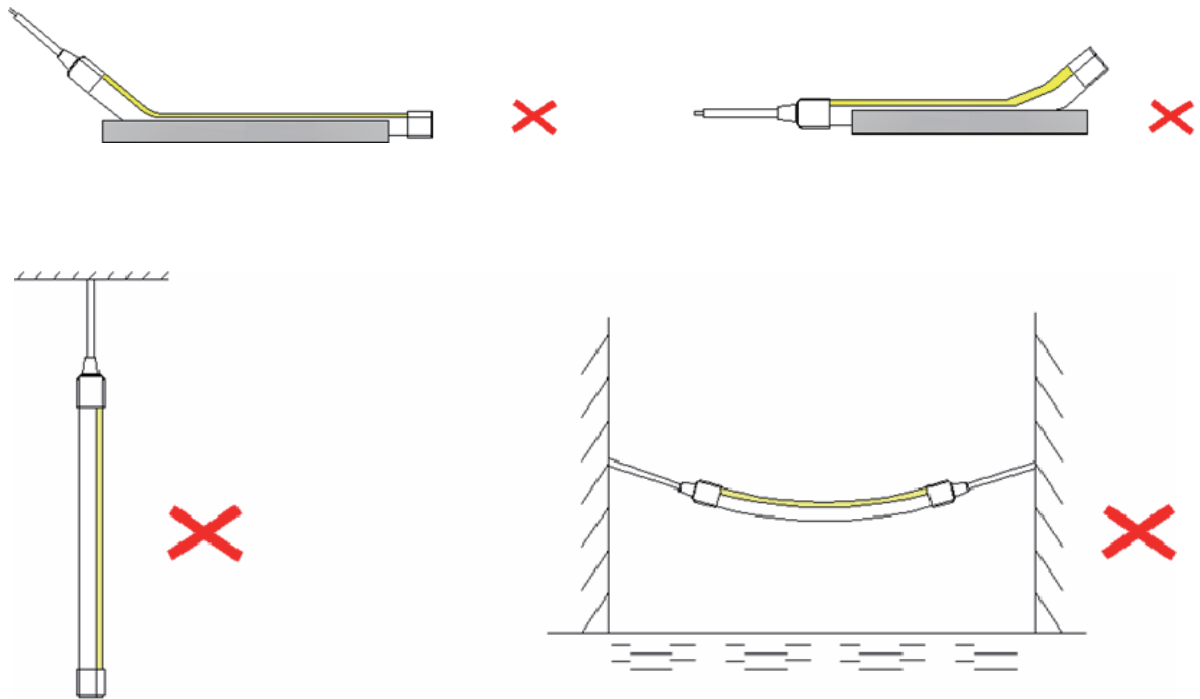



6. Press the neon flex into mounted aluminum profile in one direction (Angle between strip and aluminum <math><15^\circ</math> degrees).



















7. Incorrect installation like below pictures could lead to product function failure.





 **Cautions**

IP20	IP54	IP65	IP67	IP68
 Do not press the surface of LED	 Pay attention to high temperature environment	 Do not use in strong water waves environment	 Resist strong water waves impact	 Can apply to underwater do not deeper than 1m
 Pay attention to damp-proof and dustproof	 Do not apply to rainy environment	 Can be applied to rainy environment	 Do not apply to underwater environment for a long time	 No direct sunlight

 Do not tie a knot	 Do not winding	 Do not twist	 Do not cut when it is working	 Recommended the continuous working time do not exceed 12 hours daily	 Operating temperature -40°~+65° (-40°F~+149°F)	 Storage temperature 0°C~+60°C (32°F~+140°F)	 Operated by professionals
 Pay attention to the application environment	 IP Level will change after cutting	 Do not pull and crash	 Connected to power supply every 5 meters	 Power supply must be connected to ground(GND)	 The minimum bending diameter > 60mm	 Power supply retain > 20%	 Note the positive and negative poles

 For cutting LED strip operation, it is necessary to use the standard accessories provided by Dilux (e.g. DC wire, end-cap, front-cap, adhesive, etc.), and according to the correct cutting and connecting method for the installation.

 For avoiding LED get vulcanized, LED strip should be installed in the environment where does not has oil and corrosive substances. Such as these substances which contain Sulphur, Bromine, Iodine and Chlorine. Some other chemical elements which will cause Aromatic hydrocarbons releasing (such as: methylbenzene, xylene, methyl acetoacetate Ethyl acetate etc.). The environment in which includes strong acid and strong base.

 During the warranty period, only defective products are acceptable to be replaced by the factory. Factory is not responsible for other expenses because of replacement, such as transportation fee, installation fee, etc..

** If you do not follow the above "Cautions" to operate and result in damaging the product, the factory will not accept maintenance and return.

**The right of final interpretation is owned by Dilux.