

# Product Specification

## Neon Flex Vertical Bending Single Color Series (Type TC)

WW-FLS102T28XX140TC-24(WCP)-1000-XR-V-1018-XX-TR  
&  
WW-FLS102T28XX140TC-24(WCP)-1000-XR-V-1018-XX-  
TR-EP  
( Removal Light Source )

Apply to ERP Regulation (EU) 2019/2020



HK Office :

Unit 1901, 19th Floor, NanYang Plaza, No. 57 Hung To Road  
Kwun Tong, Kowloon, Hong Kong

China Factory :

Zhiyang Science and Technology Park, 10 Zhiyang Road, Zhangge,  
Fucheng Street, Longhua District, Shenzhen, Guangdong, China

Tel : (852) 3152 3059 (10 lines)

Fax : (852) 3152 3039



Tel : (86) 755 8601 9190



Fax : (86) 755 8601 9197

### Product Features

- High quality FPC
- Dilux self-encapsulated LED
- Light source lifetime:50K hours
- Light source removable
- Meet (EU) 2019/2020 ERP regulations
- Horizontal bending
- High quality silicone material
- IP67&IP65 waterproof
- Min.Bending Diameter:Φ140mm
- Single-ended power supply maximum length: 10m

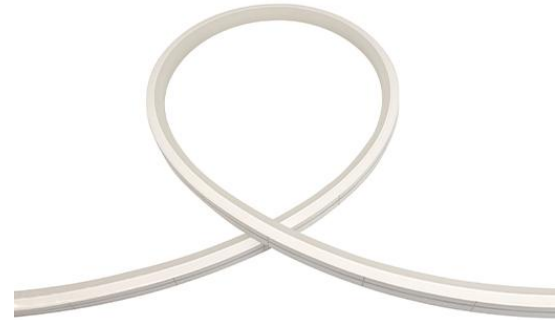
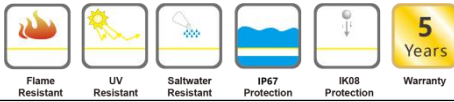

### Technology info

- Lighting Technology: LED
- DLS or NDLS: NDLS
- MLS or NMLS: NMLS
- Type of light source: SMD2835
- Energy consumption KW/1000h/0.5M:5.6
- Beam angle : 120°
- Survival factor ( Annex V/EU2019-2020 ) :90%

### Harmonised Standards

EMC

- EN55015:2013+A1
- EN61547:2009
- EN60598-1:2015
- EN60598-2-20:2015
- EN62493:2015
- EN62471:2008

## Parameters

Test condition:

- Surrounding temperature: 26°C.
- Test while turning on.

Neon Flex									
Neon Flex Model No.	CRI (Ra)	Rf	Rg	Typ. Power (W/M)	Max. Power (W/M)	Color	Neon Flex Color Temp.(K) Wavelength(nm)	Typ. Luminous Flux LM/M(39.37in)	Rated voltage
WW-FLS102T28WW140TC-24(WCP)-1000-HR-V-1018-XX-TR WW-FLS102T28WW140TC-24(WCP)-1000-HR-V-1018-XX-TR-EP	≥80	82	96	11.85	13.03	Warm White	2500K	740	DC24V
Warm White						2700K	740	DC24V	
Warm White						3000K	780	DC24V	
Natural White						4000K	780	DC24V	
Standard White						6000K	780	DC24V	
WW-FLS102T28WW140TC-24(WCP)-1000-UR-V-1018-XX-TR WW-FLS102T28WW140TC-24(WCP)-1000-UR-V-1018-XX-TR-EP						≥90	90	100	11.85
Warm White	2700K	660	DC24V						
Warm White	3000K	700	DC24V						
Natural White	4000K	700	DC24V						
Standard White	6000K	700	DC24V						
WW-FLS102T28WW140TC-24(WCP)-1000-UR-V-1018-XX-TR WW-FLS102T28WW140TC-24(WCP)-1000-UR-V-1018-XX-TR-EP	Warm White	2500K	660	DC24V					

- SDCM for light source: ≤6 (alternative ≤3).
- The typ. Luminous flux tolerance range is ±10% (subject to the manufacturer's instrument test).

## Parameters for Removal Light Source

Test condition:

- Surrounding temperature: 26 °C.
- Test after 10 mins turned on.

Removal of Light Source											
Neon Flex Model No.	CRI (Ra)	Rf	Rg	Typical Power (W/M)	Max. Power (W/M)	Color	LED Color Temp.(K) Wavelength(nm)*	Typ. Luminous Flux LM/M(39.37in)	Lumen/wat t	Energy Efficiency class	Rated voltage
WW-FLS102T28WW140TC-24(WCP)-1000-HR-V-1018-XX-TR WW-FLS102T28WW140TC-24(WCP)-1000-HR-V-1018-XX-TR-EP	≥80	82	96	11.2	12.32	Warm White	2700K	1296	116	E	DC24V
Warm White						3000K	1326	118	E	DC24V	
Warm White						3500K	1352	121	E	DC24V	
Natural White						4700K	1338	119	E	DC24V	
Standard White						8000K	1346	120	E	DC24V	
WW-FLS102T28WW140TC-24(WCP)-1000-UR-V-1018-XX-TR WW-FLS102T28WW140TC-24(WCP)-1000-UR-V-1018-XX-TR-EP						≥90	90	100	11.2	12.32	Warm White
Warm White	3000K	1104	98	F	DC24V						
Warm White	3500K	1156	103	F	DC24V						
Natural White	4700K	1190	106	F	DC24V						
Standard White	8000K	1206	108	F	DC24V						
WW-FLS102T28WW140TC-24(WCP)-1000-UR-V-1018-XX-TR WW-FLS102T28WW140TC-24(WCP)-1000-UR-V-1018-XX-TR-EP											

Remarks:

- \*The above color temperature is the color temperature of LED source.
- The typ. Luminous flux tolerance range is ±10% (subject to the manufacturer's instrument test).

ErP Note:

- Measured power ≤ Pon +5% ;
- Measured lumen ≥Useful luminous flux -10%;
- Measured CRI ≥ Declared CRI-2
- The above technical data, including typical power are based on the test of 0.5m.

## Parameters for Removal Light Source

Test condition:

- Surrounding temperature: 26°C.
- Test while turning on.

Removal of Light Source									
Neon Flex Model No.	CRI (Ra)	Rf	Rg	Typical Power (W/M)	Max. Power (W/M)	Color	Range of LED Color Temp.(K) Wavelength(nm) <sup>a</sup>	Typ. Luminous Flux LM/M(39.3 7in)	Rated voltage
WW-FLS102T28WW140TC-24(WCP)-1000-HR-V-1018-XX-TR	≥80	82	96	11.7	12.87	Warm White	2600-2900K	1296	DC24V
WW-FLS102T28WW140TC-24(WCP)-1000-HR-V-1018-XX-TR-EP						Warm White	2900-3200K	1326	DC24V
WW-FLS102T28WW140TC-24(WCP)-1000-HR-V-1018-XX-TR						Warm White	3200-3700K	1330	DC24V
WW-FLS102T28WW140TC-24(WCP)-1000-HR-V-1018-XX-TR-EP						Natural White	4500-5000K	1326	DC24V
WW-FLS102T28WW140TC-24(WCP)-1000-HR-V-1018-XX-TR						Standard White	7000-9000K	1350	DC24V
WW-FLS102T28WW140TC-24(WCP)-1000-HR-V-1018-XX-TR-EP						Warm White	2600-2900K	1046	DC24V
WW-FLS102T28WW140TC-24(WCP)-1000-UR-V-1018-XX-TR						Warm White	2900-3200K	1102	DC24V
WW-FLS102T28WW140TC-24(WCP)-1000-UR-V-1018-XX-TR-EP						Warm White	3200-3700K	1148	DC24V
WW-FLS102T28WW140TC-24(WCP)-1000-UR-V-1018-XX-TR	≥90	90	100	11.7	12.87	Natural White	4500-5000K	1184	DC24V
WW-FLS102T28WW140TC-24(WCP)-1000-UR-V-1018-XX-TR-EP						Standard White	7000-9000K	1208	DC24V
WW-FLS102T28NW140TC-24(WCP)-1000-UR-V-1018-XX-TR						Warm White	2600-2900K	1046	DC24V
WW-FLS102T28NW140TC-24(WCP)-1000-UR-V-1018-XX-TR-EP						Warm White	2900-3200K	1102	DC24V

Remarks:

- \* The above color temperature is the color temperature of LED source.
- SDCM for light source: ≤6 (alternative ≤3).
- The typ. Luminous flux tolerance range is ±10% (subject to the manufacturer's instrument test).

Optical Test Diagram

Neon Flex

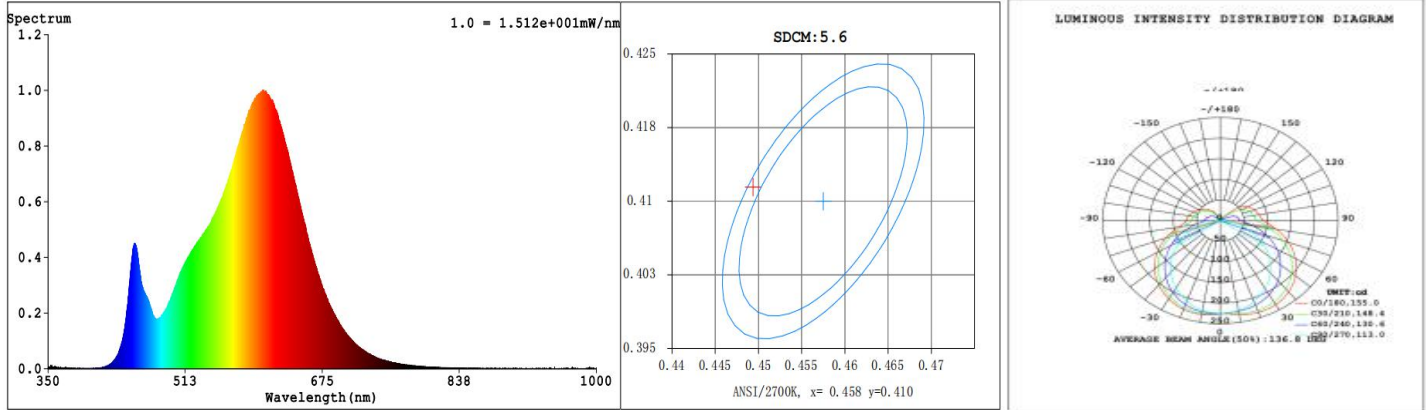

Removal of Light Source

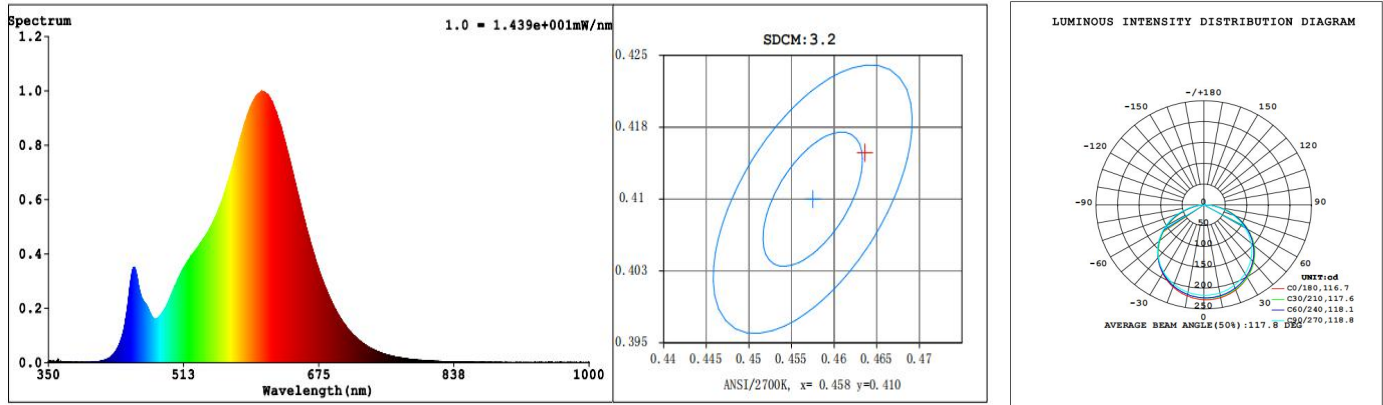

## Circuit Diagram

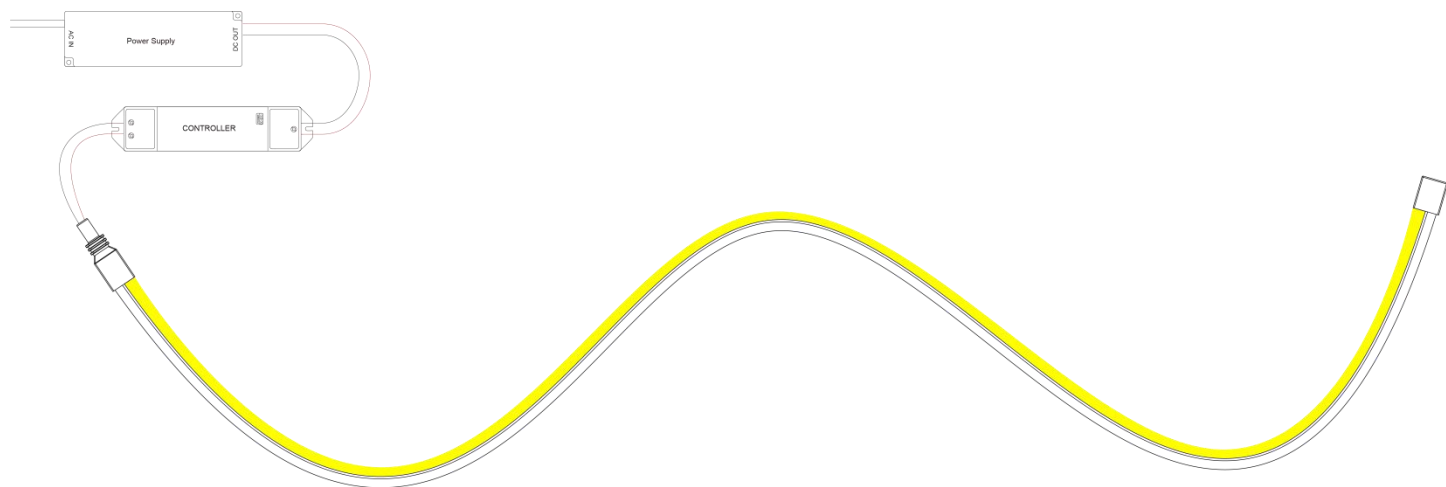

**Dimension Drawing**  
**Neon Flex**

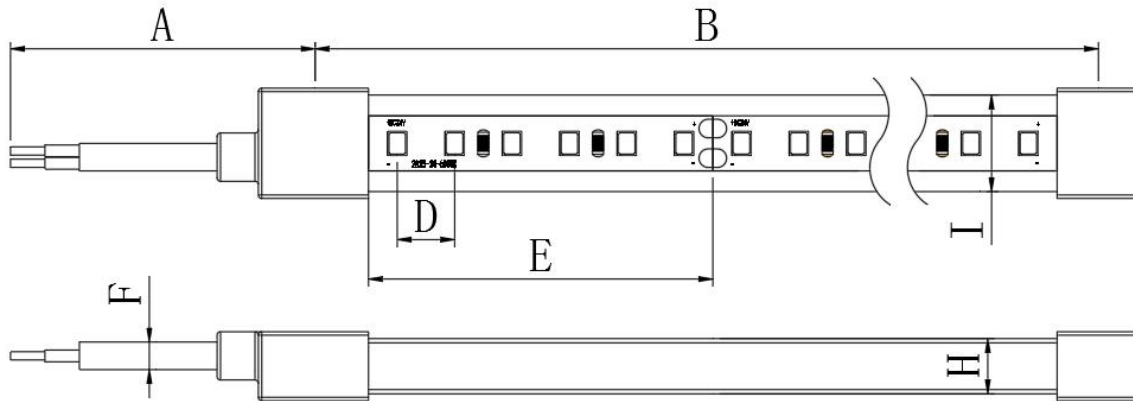

A	B	D	E	F	H	I
Cable Length	Strip length	Distance of LEDS	Cutting unit	Cable diameter	Strip thickness	Strip width
300±10mm	10000±50mm	7.14±0.2mm	50±0.2mm	6.0±0.2mm	10±0.5mm	10±0.5mm



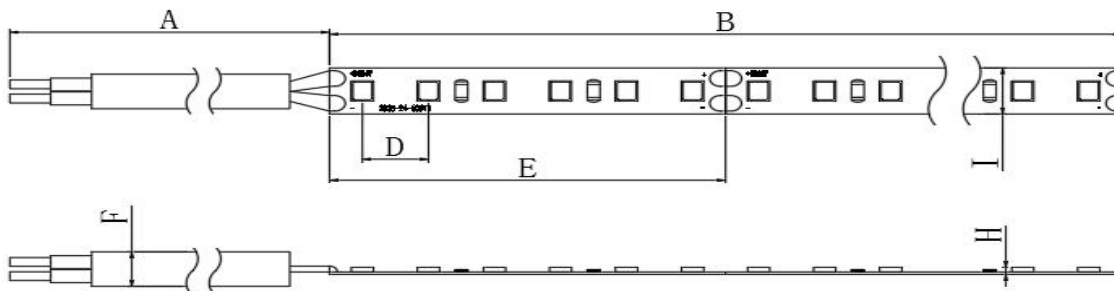



**Removal of Light Source**

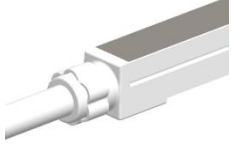
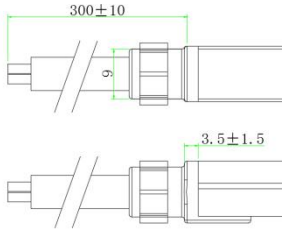

A	B	D	E	F	H	I
Cable Length	Strip length	Distance of LEDS	Cutting unit	Cable diameter	Strip thickness	Strip width
300±10mm	10000±50mm	7.14±0.2mm	50±0.2mm	6.0±0.2mm	1.2±0.2mm	8±0.2mm

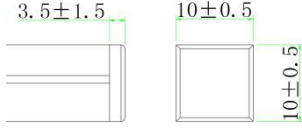

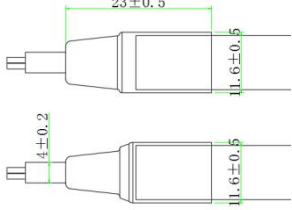
**Front & end caps**

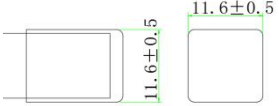
Cable Types	Model No.	Image	Dimension	IP Rating
Same Width	TC10X10-TS2			IP65
				
Same Width	TC10X10-TF			IP65
				

Optical Parameters

Distribution Curve Flux

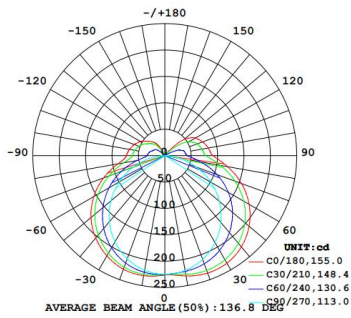

Illuminance

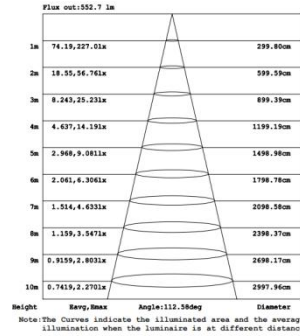

Figures of typical characteristics

Relation of Working Temperature and Power

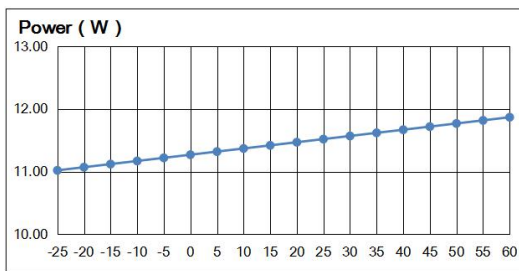

Relation of luminous flux and strip length (Only suitable for white series)

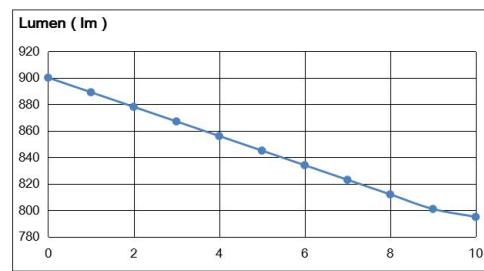

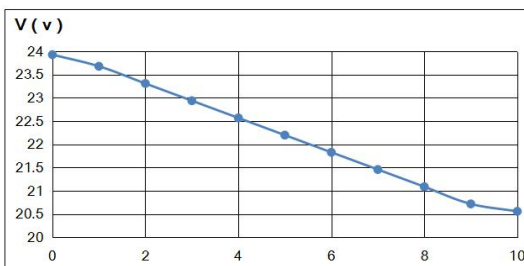

Relation of operating voltage and strip length



### Standard Accessories

Image	Part No.	Description
	<p>WW-PC1212-0025</p>	<p>Installation accessories set (PC mounting clips, screws)</p>

### Optional Accessories

Image	Part No.	Description
	<p>WW-AP1211-200</p>	<p>Aluminum Profile: L2000*W11.7*H10.5mm</p>
	<p>WW-LG1110-500</p>	<p>TC-type 10mm moldable profile</p>
	<p>WW-FLS102TC-CW(10mm)-TF</p>	<p>Cutting accessories set (Front &amp; end cap, power cord)</p>

**Packaging**

**Solution 1:  
For Product Length≤5M**



Ingress protection rating	Bag size	Inner carton		Outer carton		N.W	G.W	Outer carton volume
		Size	Reel/ctn	Size	Reel/ctn			
IP65	/	/	/	420*350*365mm	23	12.43KG ±10%	13.52 KG ±10%	0.0537m³
	/	/	/	16.54*13.78 *14.37 in	23	27.41 Lbs ±10%	29.80 Lbs ±10%	1.898ft³

**Solution 2:  
For Product Length=5M**

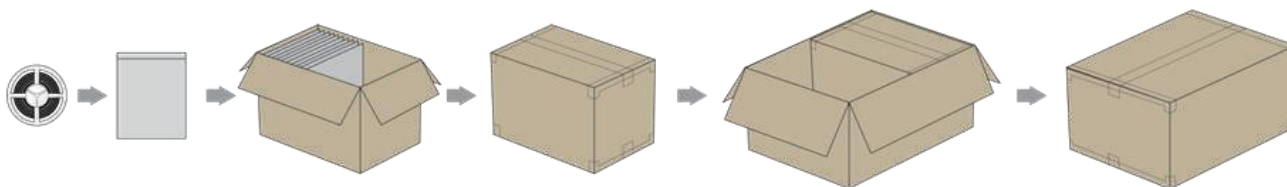

Ingress protection rating	Bag size	Inner carton		Outer carton		N.W	G.W	Outer carton volume
		Size	Reel/ctn	Size	Reel/ctn			
IP65	350*380*0.14mm	330*200*330mm	6	420*350*365mm	12	7.46KG ±10%	11.76KG ±10%	0.0537m³
	13.78*14.96*0.006 in	12.99*7.87*12.99 in	6	16.54*13.78 *14.37 in	12	16.44 Lbs ±10%	25.92 Lbs ±10%	1.898ft³

**Solution 3:  
For Product Length=10M**

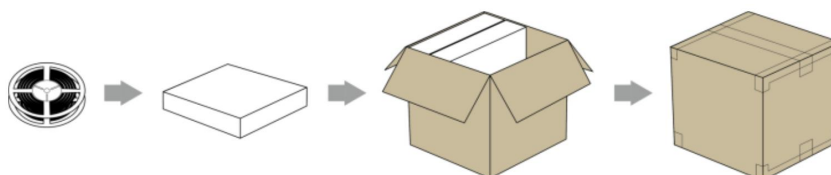

Ingress protection rating	Bag size	Inner carton		Outer carton		N.W	G.W	Outer carton volume
		Size	Reel/ctn	Size	Reel/ctn			
IP65	254*45mm	270*255*53mm	1	280*240*283mm	4	4.97 KG ±10%	6.70KG ±10%	0.0190m³
	10*1.77in	10.63*10.04*2.08 in	1	11.02*9.45 *11.14 in	4	10.95 Lbs ±10%	14.76 Lbs ±10%	0.6708ft³

**For Product Length=20M**

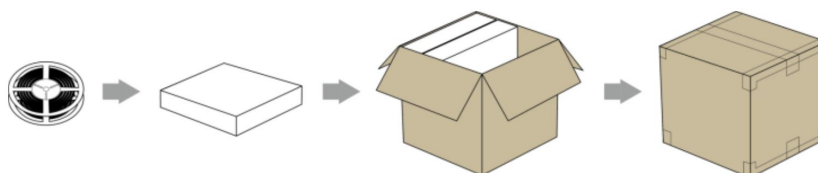

Ingress protection rating	Bag size	Inner carton		Outer carton		N.W	G.W	Outer carton volume
		Size	Reel/ctn	Size	Reel/ctn			
IP65	330*50mm	345*330*61mm	1	362*265*350mm	4	9.95 KG ±10%	13.05KG ±10%	0.0357m³
	12.99*1.96in	13.58*12.99*2.4in	1	14.25*10.43*13.77in	4	21.93 Lbs ±10%	28.76 Lbs ±10%	1.2627ft³

**Remarks :**

- Please contact our sales manager for customized package (color box, blister etc.)

## Instruction of Removal Light Source

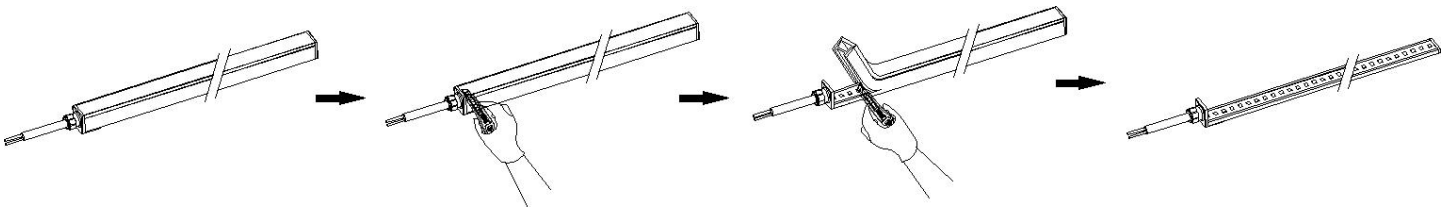

## Cutting Instruction

- The cutting line logo on the Neon strip marked by calculated dimension, it has a little bit deviation between internal cutting line marked on the PCB surface;
- Please follow the cutting guidance as below:

Step 1: Fine the cutting line on the silicone coating, slice the silicone coating vertically by knife along the cutting line, but do not hurt the PCB inside.

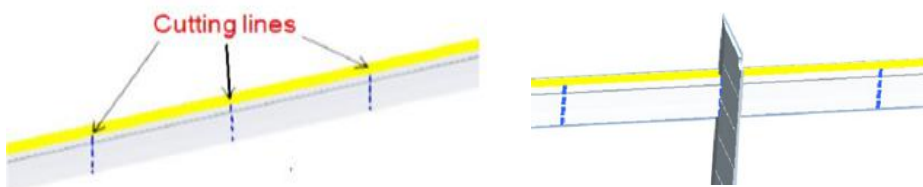

Step 2: Split the broken silicone coating and observe the deviation between "Cutting line on the PCB" and "Cutting line on the silicone coating side"

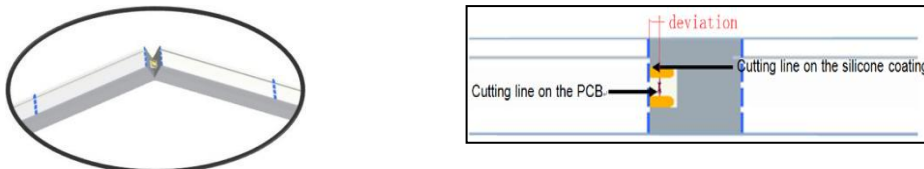

Step 3: Find the cutting line on the PCB, adjust to the exact cutting location and slice the silicone coating again.



Step 4: Finally, use scissor to separate the Neon Flex along the cutting line on the PCB.

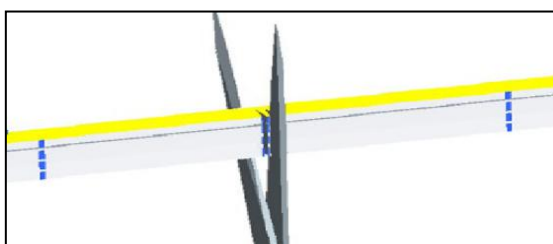

## Installation Guidance

1. Do not bend smaller than allowed minimum bending diameter

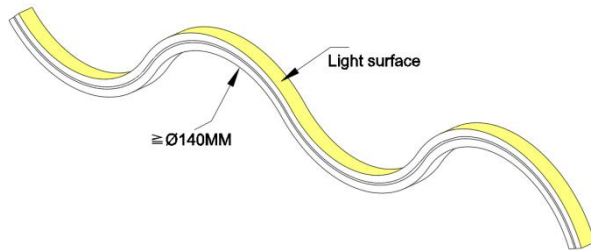

2. The neon strip can only be bent laterally (Along the FPC inside).

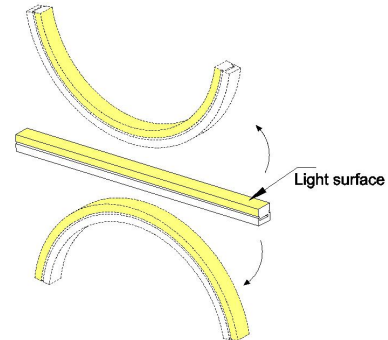

3. Don't bend the LED strip Horizontal, it will damage the circuit inside and cause product function failure.

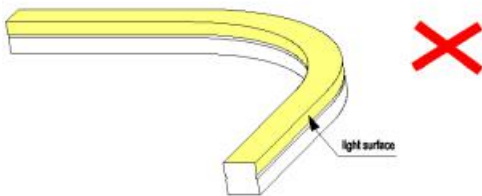

4. Don't twist the LED strip, it will damage the circuit inside and cause product function failure.

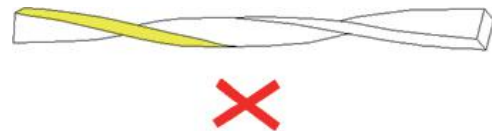

5. Do not hang or suspend the Neon strip in the air.

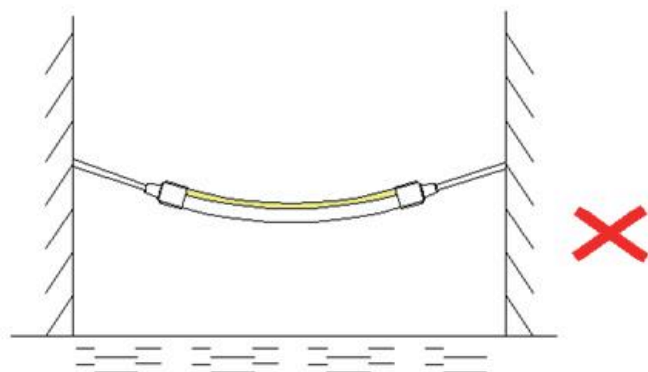
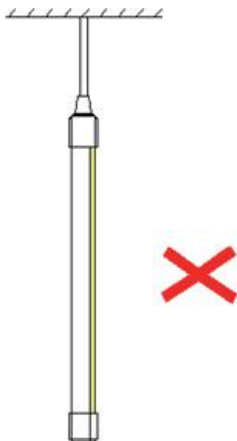











6、 Press the neon flex into mounted aluminum profile in one direction (Angle between strip and aluminum <math>< 15^\circ</math> degrees).













7、 Incorrect installation like below pictures could lead to product function failure.





 **Cautions**

IP20	IP54	IP65	IP67	IP68
 Do not press the surface of LED	 Pay attention to high temperature environment	 Do not use in strong water waves environment	 Resist strong water waves impact	 Can apply to underwater do not deeper than 1m
 Pay attention to damp-proof and dustproof	 Do not apply to rainy environment	 Can be applied to rainy environment	 Do not apply to underwater environment for a long time	 No direct sunlight

 Do not tie a knot	 Do not winding	 Do not twist	 Do not cut when it is working	 Recommended the continuous working time do not exceed 12 hours daily	 Operating temperature -40°~+65° (-40°F~+149°F)	 Storage temperature 0°C~+60°C (32°F~+140°F)	 Operated by professionals
 Pay attention to the application environment	 IP Level will change after cutting	 Do not pull and crash	 Connected to power supply every 5 meters	 Power supply must be connected to ground(GND)	 The minimum bending diameter > 60mm	 Power supply retain > 20%	 Note the positive and negative poles

 For cutting LED strip operation, it is necessary to use the standard accessories provided by Dilux (e.g. DC wire, end-cap, front-cap, adhesive, etc.), and according to the correct cutting and connecting method for the installation.

 For avoiding LED get vulcanized, LED strip should be installed in the environment where does not has oil and corrosive substances. Such as these substances which contain Sulphur, Bromine, Iodine and Chlorine. Some other chemical elements which will cause Aromatic hydrocarbons releasing(such as: methylbenzene, xylene, methyl acetoacetate Ethyl acetate etc.).The environment in which includes strong acid and strong base.

 During the warranty period, only defective products are acceptable to be replaced by the factory. Factory is not responsible for other expenses because of replacement, such as transportation fee, installation fee, etc..

\*\* If you do not follow the above "Cautions" to operate and result in damaging the product, the factory will not accept maintenance and return.  
\*\*The right of final interpretation is owned by Dilux.