

Product Specification

DC Flexible LED Strip Luminaire CC driven Series

2835 LED 26mm FPC 280LEDs/M

WW-FLS102T28XW280B-CC(WCP)(26)-30-HR
&
WW-FLS102T28XW280B-CC(WCP)(26)-30-HR-EP



HK Office :

Unit 1901, 19th Floor, NanYang Plaza, No. 57 Hung To Road
Kwun Tong, Kowloon, Hong Kong

China Factory :

Zhiyang Science and Technology Park, 10 Zhiyang Road, Zhangge,
Fucheng Street, Longhua District, Shenzhen, Guangdong, China

Tel : (852) 3152 3059 (10 lines)

Fax : (852) 3152 3039







Tel : (86) 755 8601 9190

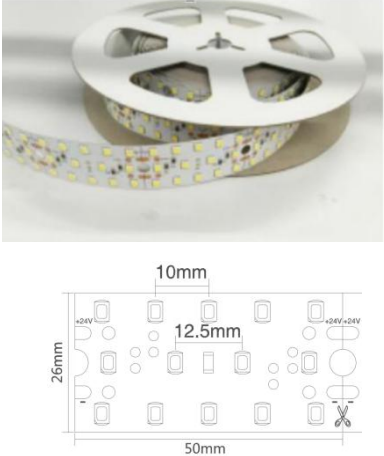

Fax : (86) 755 8601 9197

<p>Product Features</p> <ul style="list-style-type: none"> • High quality FPC, authentic 3M tape; • Self-encapsulated design 2835 LED; • Light source lifetime:50K hours(L70); • Meet (EU)2019/2020 ErP regulations. • Min. Bending Diameter: Φ60mm • Max. length(M): 3M 	
<p>Technology info</p> <ul style="list-style-type: none"> • Lighting Technology: LED • DLS or NDLS: NDLS • MLS or NMLS: NMLS 	<p>Certification Standards</p> <ul style="list-style-type: none"> • EN55015:2019 • EN61547:2009 • EN60598-1:2015 • EN60598-2-20:2015 • EN62493:2015 • EN62471:2008

Non-ErP Waterproof Type	 
	Naked Strip
	5 Years Warranty

ErP Waterproof Type	 
	Naked Strip
	5 Years Warranty

WW-FLS102T28XW280B-CC(WCP)(26)-30-HR

Parameters for non-Erp

IP Grade	Model NO.	CRI (Ra)	Rf	Rg	Typical Power (W/M)	Max. Power (W/M)	Color	LED Color Temp.(K) Wavelength(nm)*	3SDCM LED Color Temp.(K) Wavelength(nm)**	Typ. Luminous Flux LM/M(39.37in)	Rated voltage
E 20	WW-FLS102T28XW280B-CC(WCP)(26)-30-HR	80	82	96	24.00	27.60	Warm White	2500K	/	3740	DC 42-44.8V
							Warm White	2700K	/	3740	
							Warm White	3000K	/	3740	
							Natural White	4000K	/	4100	
							Standard White	6000K	/	4100	

Remarks:

- *The above color temperature is the color temperature of LED source.
- **Indicates SDCM<3 model is available, part number will add the suffix "-3S".
- The typ. Luminous flux tolerance range is ±15% (subject to the manufacturer's instrument test).

Test condition of above technical data:

- Surrounding temperature: 26°C.
- Test while turning on.

WW-FLS102T28XW280B-CC(WCP)(26)-30-HR-EP

Parameters for Erp

IP Grade	Model NO.	CRI (Ra)	Rf	Rg	Typical Power (W/M)	Max. Power (W/M)	Color	LED Color Temp.(K) Wavelength(nm)*	Luminous Flux LM/M(39.37')	Lumen/watt	Energy Efficiency class	Rated voltage
E 20	WW-FLS102T28XW280B-CC(WCP)(26)-30-HR-EP	80	82	96	26.00	28.60	Warm White	2700K	3579	138	D	DC 42-44.8V
							Warm White	3000K	3777	145	D	
							Natural White	4000K	4017	154	D	
							Standard White	6000K	3991	153	D	

Remarks:

- *The above color temperature is the color temperature of LED source.
- While SDCM<3 model is available, part number will add the suffix "-3S".

Test condition of above technical data:

- Surrounding temperature: 26 °C.
- Test after 10 mins turned on.

ErP Note:

- According to the new ErP 2019/2020 regulation for each 0.5m or nearest 0.5m strip, the following requirements must be met:
- Measured power \leq Pon +5% ;
- Measured lumen \geq Useful luminous flux -10%;
- Measured CRI \geq Declared CRI-2
- The above technical data, including typical power are based on the test of 0.5m.

Optical Test Diagram

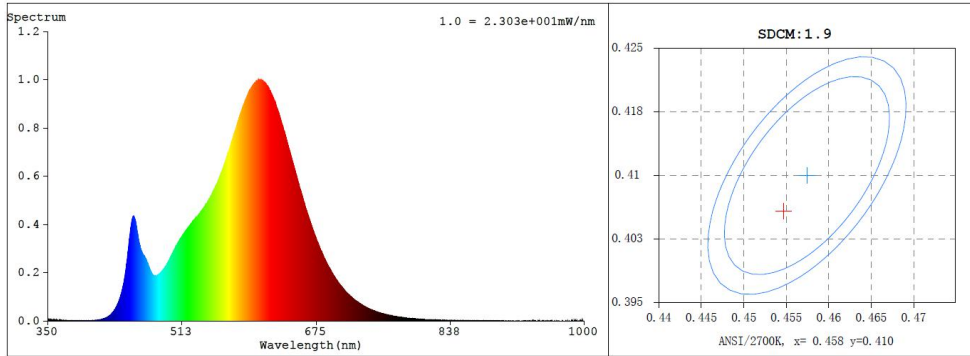

LUMINOUS INTENSITY DISTRIBUTION DIAGRAM

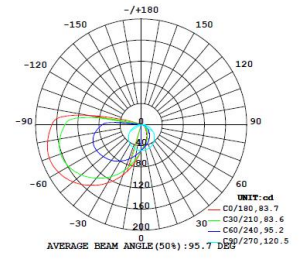

Dimension Drawing

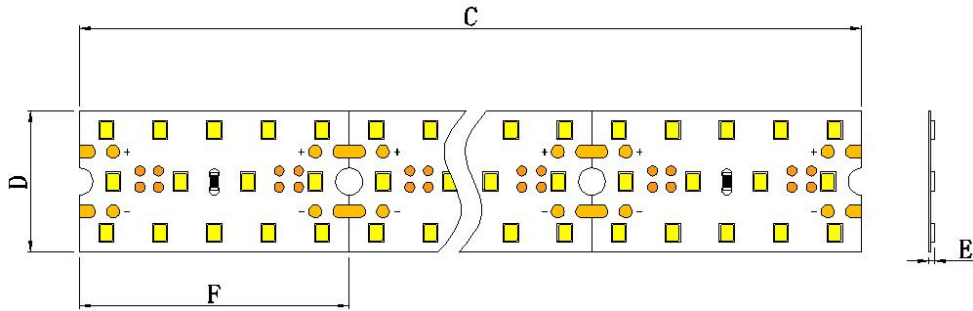

IP Grade	A Cable Length	B cable diameter	C Strip length	D Strip width	E Strip thickness	F Front cap length	G End cap length	H Cap width	I Cap thickness
E 20	/	/	3000±5mm	26±0.5mm	1.2±0.5mm	50±1mm	/	/	/
	/	/	118.11±0.197in	1.02±0.02in	0.047±0.02in	1.99±0.04in	/	/	/

Remarks:

- If you need further information, please contact our sales manager.

Circuit Diagram

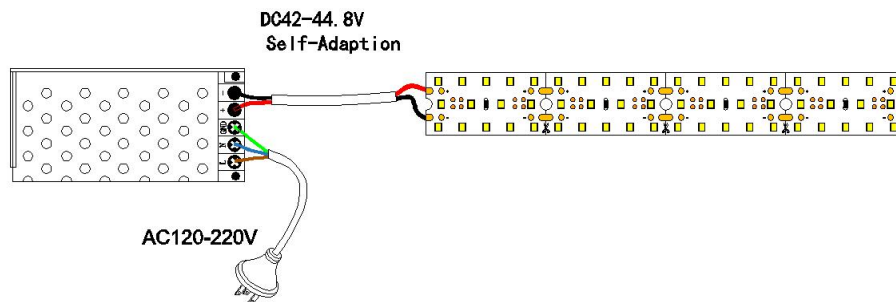

Packaging Diagram

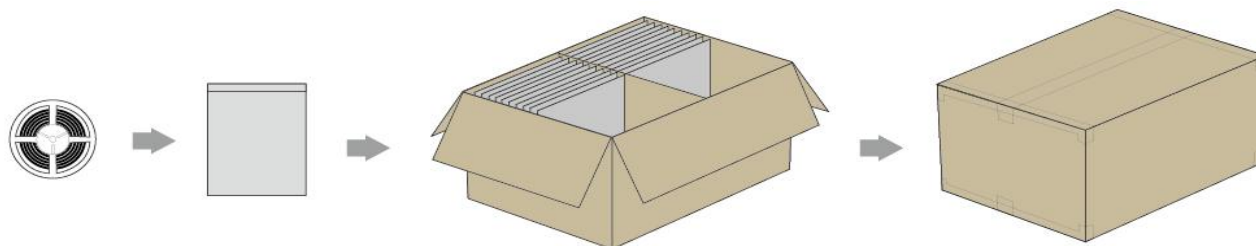











Packaging information

















Ingress protection rating	Bag size	Inner carton		Outer carton		N.W	G.W	Outer carton volume
		Size	Reel/ctn	Size	Reel/ctn			
IP20	250*270*0.14mm	/	/	440*400 *260mm	24	3.71KG ±10%	8.19KG ±10%	0.04576 m ³
	9.84*10.63*0.0056in	/	/	17.32*15.75 *10.24 in	24	6.87Lbs ±10%	18.04Lbs ±10%	1.616 ft ³

Remarks :

- Please contact our sales manager for customized package (color box, blister etc.)

 **Cautions**

IP20	IP54	IP65	IP67	IP68
				
Do not press the surface of LED	Pay attention to high temperature environment	Do not use in strong water waves environment	Resist strong water waves impact	Can apply to underwater do not deeper than 1m
				
Pay attention to damp-proof and dustproof	Do not apply to rainy environment	Can be applied to rainy environment	Do not apply to underwater environment for a long time	No direct sunlight

							
Do not tie a knot	Do not winding	Do not twist	Do not cut when it is working	Recommended the continuous working time do not exceed 12 hours daily	-20°C~+45°C (-4°F~+113°F)	0°C~+60°C (32°F~+140°F)	Operated by professionals
							
Pay attention to the application environment	IP Level will change after cutting	Do not pull and crash	Connected to power supply every 5 meters	Power supply must be connected to ground(GND)	The minimum bending diameter > 60mm	Power supply retain > 20%	Note the positive and negative poles

 For cutting LED strip operation, it is necessary to use the standard accessories provided by Dilux (e.g. DC wire, end-cap, front-cap, adhesive, etc.), and according to the correct cutting and connecting method for the installation.

 For avoiding LED get vulcanized, LED strip should be installed in the environment where does not has oil and corrosive substances. Such as these substances which contain Sulphur, Bromine, Iodine and Chlorine. Some other chemical elements which will cause Aromatic hydrocarbons releasing(such as: methylbenzene, xylene, methyl acetoacetate Ethyl acetate etc.),The environment in which includes strong acid and strong base.

 During the warranty period, only defective products are acceptable to be replaced by the factory. Factory is not responsible for other expenses because of replacement, such as transportation fee, installation fee, etc..

**** If you do not follow the above "Cautions" to operate and result in damaging the product, the factory will not accept maintenance and return. ****
****The right of final interpretation is owned by Dilux.**