

# Product Specification

## Modeling Profile

WW-AP1612C

HK Office :

Unit 1901, 19th Floor, NanYang Plaza, No. 57 HungTo Road  
Kwun Tong, Kowloon, Hong Kong

Tel : (852) 3152 3059 (10 lines)

Fax : (852) 3152 3039



China Factory :

Zhiyang Science and Technology Park, 10 Zhiyang Road, Zhangge,  
Fucheng Street, Longhua District, Shenzhen, Guangdong, China

Tel : (86) 755 8601 9190

Fax : (86) 755 8601 9197

**WW-AP1612C-XXX**

**Features**

- Adopt aviation aluminum 6063-T5, outstanding heat dissipation performance.
- High quality surface finish with silver, white or black.
- No screw tight front-end cap, with hole & without hole front-end cap options.
- Uniform illumination
- Easy installation



**Dimension Drawing**

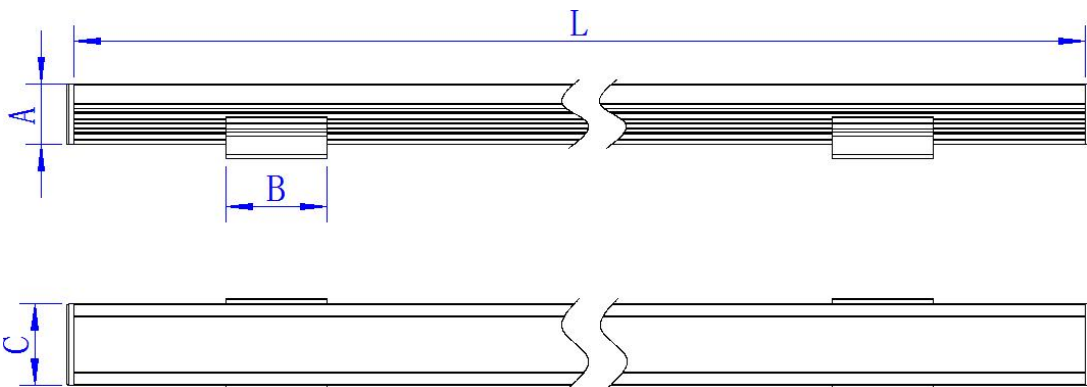



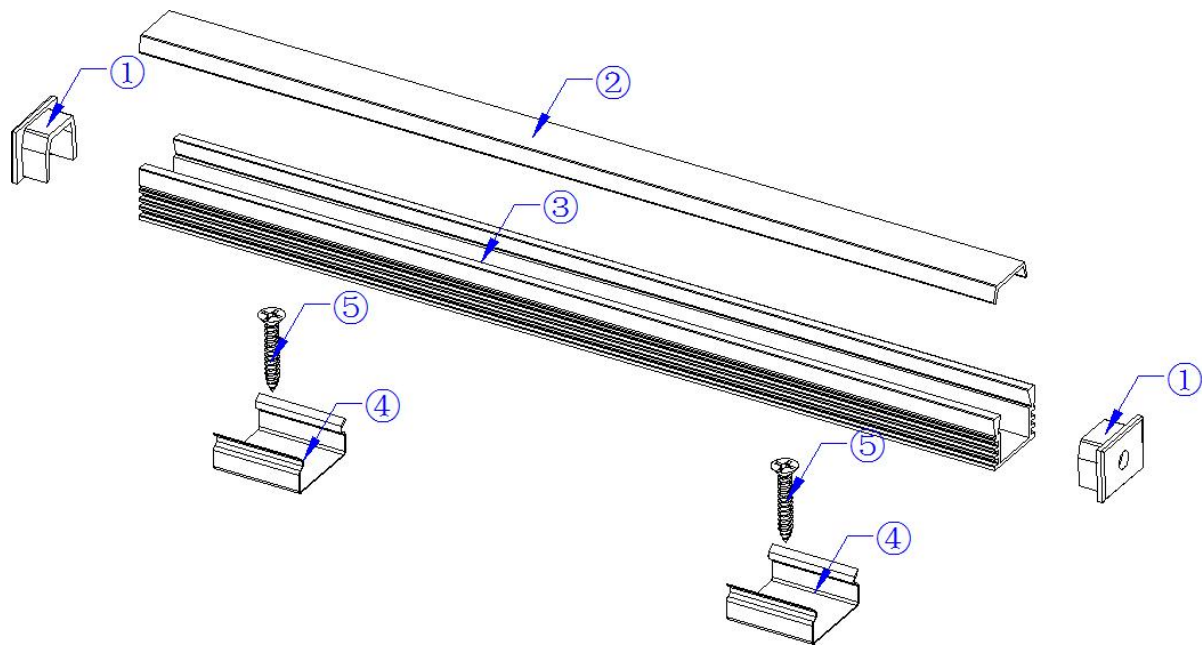

WW-AP1612C-212			
A	B	C	L
13.11±0.2mm	20±0.2mm	16±0.2mm	2120±2mm
0.516±0.007in	0.787±0.007in	0.63±0.007in	83.46±0.079in

WW-AP1612C-100			
A	B	C	L
12±0.1mm	20±0.2mm	16±0.1mm	1000±2mm
0.47±0.004in	0.787±0.008in	0.63±0.004in	39.37±0.079in

## Exploded views

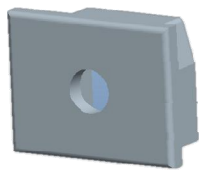
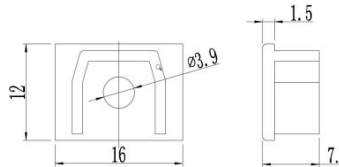

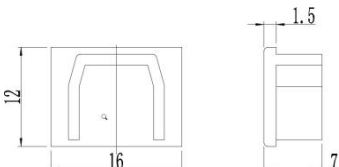
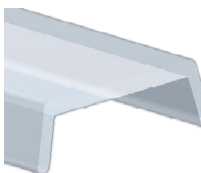
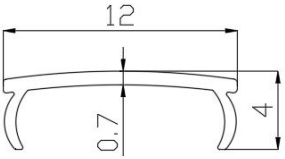
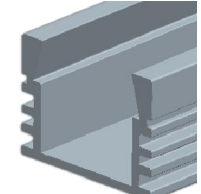
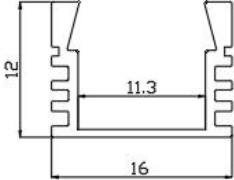
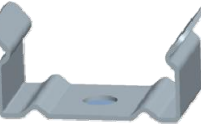
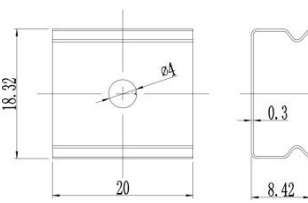
Standard parts

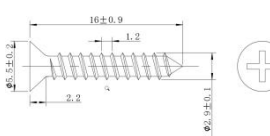
	Picture	Product name	Market model	Product size	Characteristics
①		Plug (Pass through the wire hole)	AP1612C-DT		PC
①		Tail cover	AP1612C-DT		PC
②		Lens (PC cover)	AP1612C-CV		PC(The light transmittance is 83%)
③		Aluminum profile	AP1612B-LC		6063-T5
④		Fastener	AP1612B-SM		Stainless steel
⑤		Cross tapping screw	\		Crosstappings crew

Remarks:

- Because PC material has expansion and contraction feature, the linear expansion coefficient of PC material is  $7 \times 10^{-5} \text{ cm}^{\circ}\text{C}$ , so when the product be used in different ambient temperatures, the length of PC cover will has a little bit tolerance which can be calculated by formula.
- For example: the original length of PC cover is 2 meters, when it has been used in  $0^{\circ}\text{C}$  ambience temperature, the length of PC cover will probably contract 0-5mm. when it has been used in  $35^{\circ}\text{C}$  ambience temperature, On the contrary, the length of PC cover will probably expand 0-5mm.

**Packaging Diagram**

**For Product Length <2M**

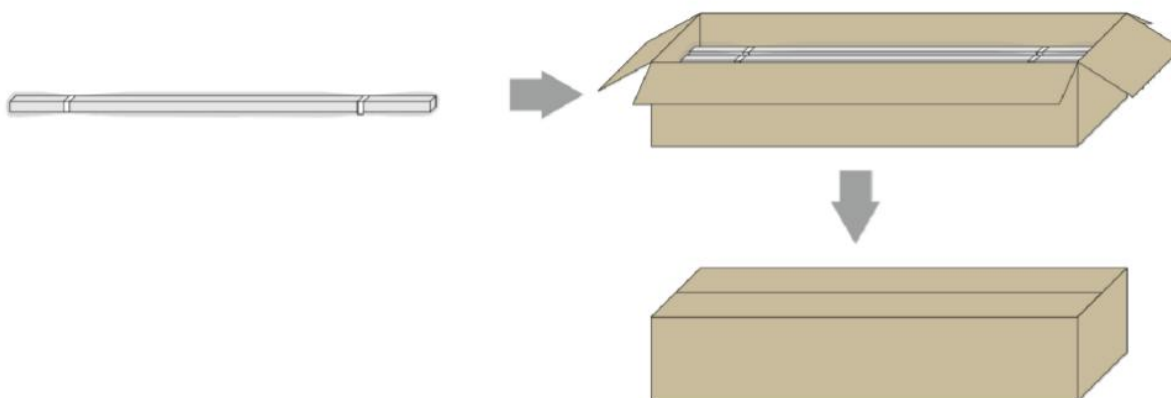

**For Product Length ≥2M**

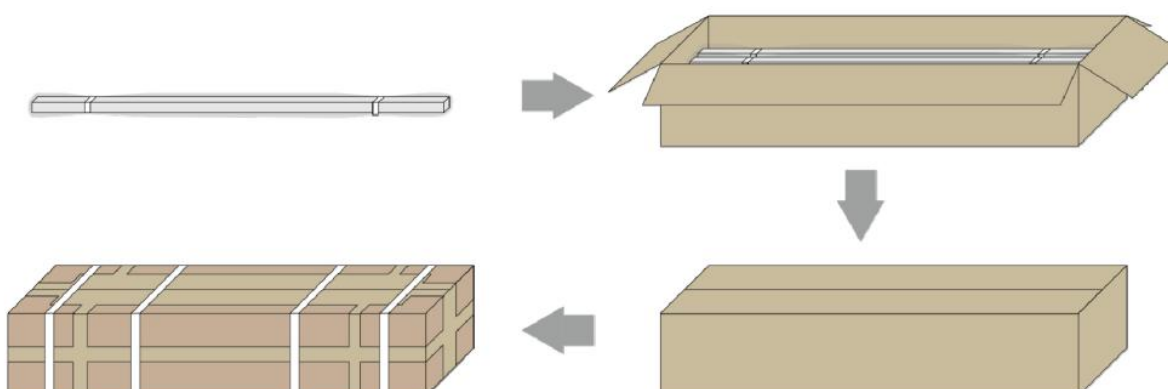

Part NO.	Outer carton			N.W		G.W		Outer carton volume	
	size		PCS /ctn						
WW-AP1612C-212	2260*225*105mm	89*8.86*4.13 in	60	8.9KG ± 10%	19.62Lbs ± 10%	9.9KG ± 10%	21.82Lbs ± 10%	0.0534 m <sup>3</sup>	1.886 cu ft
WW-AP1612C-100	1060*225*105mm	41.73*8.86*4.13in	60	6.67KG ± 10%	14.70Lbs ± 10%	7.42KG ± 10%	16.36Lbs ± 10%	0.0534 m <sup>3</sup>	1.886 cu ft

**Remark:**

- Packaging information is for reference only, shipping is subject to actual condition.

 **Cautions**



Do not use in a wet or dusty environment



Do not use in places with oil or corrosive substances



Do not pull and collide when the product is working



Install the product in an appropriate environment



Follow user manual for installation



During the warranty period, only defective products are acceptable to be replaced by the factory. Factory is not responsible for other expenses because of replacement, such as transportation fee, installation fee, etc..

**\*\* If you do not follow the above "Cautions" to operate and result in damaging the product, the factory will not accept maintenance and return.  
\*\*he right of final interpretation is owned by Dilux.**