

Product Specification

Neon Flex Vertical Bending Single Color Series (Type TC)

WW-FLS102T72XW168TC-24(WCP)-UR-1510-TS2-EM
&
WW-FLS102T72XW168TC-24(WCP)-UR-1510-TS2-EM-EP
(Removal Light Source)

Apply to ERP Regulation (EU) 2019/2020



HK Office :

Unit 1901, 19th Floor, NanYang Plaza, No. 57 Hung To Road
Kwun Tong, Kowloon, Hong Kong

China Factory :

Zhiyang Science and Technology Park, 10 Zhiyang Road, Zhangge,
Fucheng Street, Longhua District, Shenzhen, Guangdong, China

Tel : (852) 3152 3059 (10 lines)

Fax : (852) 3152 3039



Tel : (86) 755 8601 9190



Fax : (86) 755 8601 9197

Product Features

- High quality FPC
- Dilux self-encapsulated LED
- Light source lifetime:50K hours
- Light source removable
- Meet (EU) 2019/2020 ERP regulations
- Vertical bending
- High quality silicone material
- IP65 waterproof
- Min.Bending Diameter:Φ130mm



Technology info

- Lighting Technology: LED
- DLS or NDLS: NDLS
- MLS or NMLS: NMLS
- Type of light source: SMD2025
- Energy consumption KW/1000h/0.5M:2.8
- Beam angle: 90°
- Survival factor (Annex V/EU2019-2020) :90%

Harmonised Standards

EMC

- EN55015:2013+A1
- EN61547:2009
- EN60598-1:2015
- EN60598-2-20:2015
- EN62493:2015
- EN62471:2008

Parameters

Test condition:

- Surrounding temperature: 26°C.
- Test while turning on.

Neon Flex									
Neon Flex Model No.	CRI (Ra)	Rf	Rg	Typ. Power (W/M)	Max. Power (W/M)	Color	Neon Flex Color Temp.(K) Wavelength(nm)	Typ. Luminous Flux LM/M(39.37in)	Rated voltage
WW-FLS102T72WW168TC-24(WCP)-UR-1510-TS2-EM WW-FLS102T72WW168TC-24(WCP)-UR-1510-TS2-EM-EP	≥90	90	98	5.5	6.05	Warm White	2700K	422	DC24V
WW-FLS102T72WW168TC-24(WCP)-UR-1510-TS2-EM WW-FLS102T72WW168TC-24(WCP)-UR-1510-TS2-EM-EP						Warm White	3000K	434	DC24V
WW-FLS102T72NW168TC-24(WCP)-UR-1510-TS2-EM WW-FLS102T72NW168TC-24(WCP)-UR-1510-TS2-EM-EP						Natural White	4000K	452	DC24V
WW-FLS102T72SW168TC-24(WCP)-UR-1510-TS2-EM WW-FLS102T72SW168TC-24(WCP)-UR-1510-TS2-EM-EP						Standard White	6000K	448	DC24V

Remarks:

- SDCM for light source: ≤6 (alternative ≤3).
- The typ. Luminous flux tolerance range is ±10% (subject to the manufacturer's instrument test).

Parameters for Removal Light Source

Test condition:

- Surrounding temperature: 26°C.
- Test after 10 mins turned on.

Removal of Light Source											
Neon Flex Model No.	CRI (Ra)	Rf	Rg	Typical Power (W/M)	Max. Power (W/M)	Color	LED Color Temp.(K) Wavelength (nm)*	Typ. Luminous Flux LM/M(39.37in)	Lumen/watt	Energy Efficiency class	Rated voltage
WW-FLS102T72WW168TC-24(WCP)-UR-1510-TS2-EM WW-FLS102T72WW168TC-24(WCP)-UR-1510-TS2-EM-EP	≥90	90	98	5.6	6.16	Warm White	2700K	598	107	F	DC24V
WW-FLS102T72WW168TC-24(WCP)-UR-1510-TS2-EM WW-FLS102T72WW168TC-24(WCP)-UR-1510-TS2-EM-EP						Warm White	3000K	606	108	F	DC24V
WW-FLS102T72NW168TC-24(WCP)-UR-1510-TS2-EM WW-FLS102T72NW168TC-24(WCP)-UR-1510-TS2-EM-EP						Natural White	4000K	638	114	E	DC24V
WW-FLS102T72SW168TC-24(WCP)-UR-1510-TS2-EM WW-FLS102T72SW168TC-24(WCP)-UR-1510-TS2-EM-EP						Standard White	6000K	634	113	E	DC24V

Remarks:

- *The above color temperature is the color temperature of LED source.
- The typ. Luminous flux tolerance range is ±10% (subject to the manufacturer's instrument test).

ErP Note:

- Measured power ≤ Pon +5% ;
- Measured lumen ≥ Useful luminous flux -10%;
- Measured CRI ≥ Declared CRI-2
- The above technical data, including typical power are based on the test of 0.5m.

Parameters for Removal Light Source

Test condition:

- Surrounding temperature: 26°C.
- Test while turning on.

Removal of Light Source									
Neon Flex Model No.	CRI (Ra)	Rf	Rg	Typical Power (W/M)	Max. Power (W/M)	Color	Range of LED Color Temp.(K) Wavelength(nm) ^a	Typ. Luminous Flux LM/M(39.3 7in)	Rated voltage
WW-FLS102T72WW168TC-24(WCP)-UR-1510-TS2-EM WW-FLS102T72WW168TC-24(WCP)-UR-1510-TS2-EM-EP	≥90	90	98	5.5	6.05	Warm White	2600-2900K	582	DC24V
WW-FLS102T72WW168TC-24(WCP)-UR-1510-TS2-EM WW-FLS102T72WW168TC-24(WCP)-UR-1510-TS2-EM-EP				5.5	6.05	Warm White	2900-3200K	602	DC24V
WW-FLS102T72NW168TC-24(WCP)-UR-1510-TS2-EM WW-FLS102T72NW168TC-24(WCP)-UR-1510-TS2-EM-EP				5.5	6.05	Natural White	3700-4250K	636	DC24V
WW-FLS102T72SW168TC-24(WCP)-UR-1510-TS2-EM WW-FLS102T72SW168TC-24(WCP)-UR-1510-TS2-EM-EP				5.5	6.05	Standard White	5700-6500K	632	DC24V

Remarks:

- * The above color temperature is the color temperature of LED source.
- SDCM for light source: ≤6 (alternative ≤3).
- The typ. Luminous flux tolerance range is ±10% (subject to the manufacturer's instrument test).

Optical Test Diagram

Neon Flex

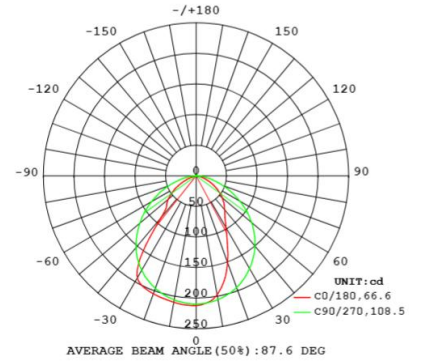
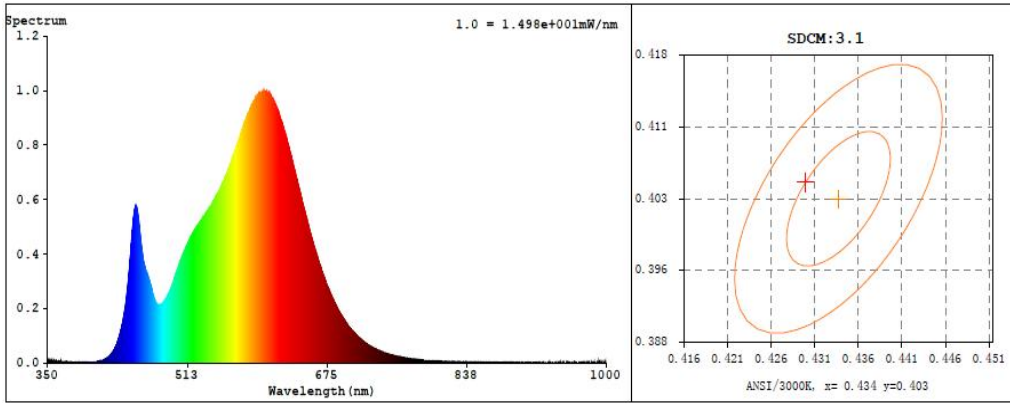

Removal of Light Source

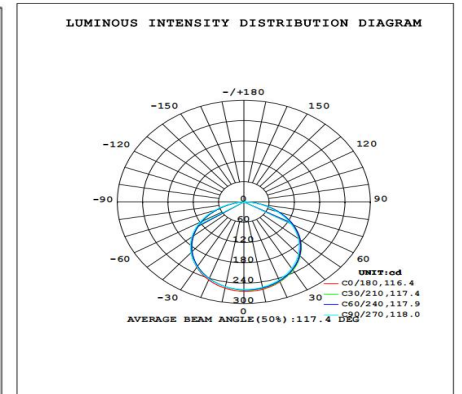
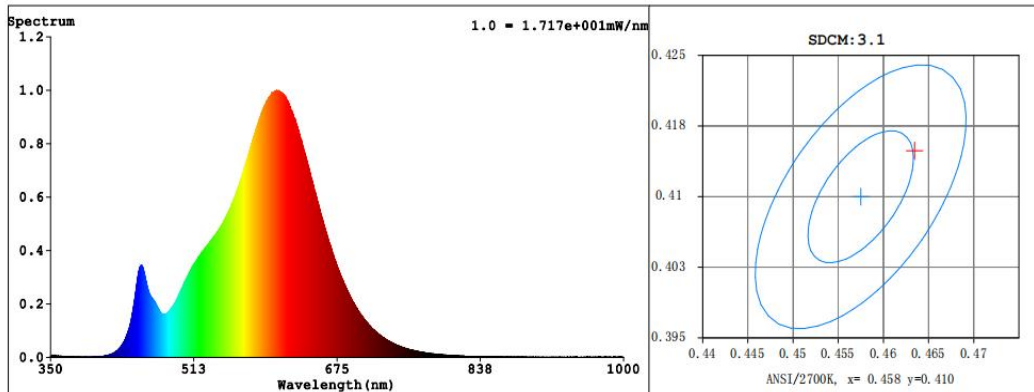

Dimension Drawing

Neon Flex

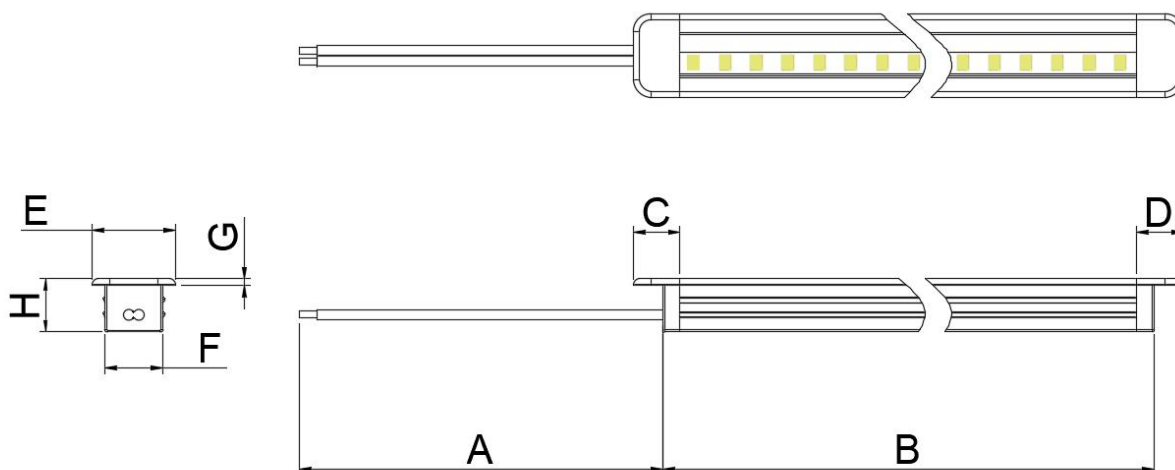

A Cable Length	B Strip length	C/D Cap width	E Strip width	F Strip width	G Lap thickness	H Cap thickness
150±10mm	5000±50mm	8±2mm	15±0.5mm	10±0.3mm	1.2±0.2mm	9.25±0.3mm
5.905±0.39in	196.85±1.97in	0.315±0.078in	0.591±0.019in	0.393±0.012in	0.047±0.0079in	0.364±0.012in

Removal of Light Source

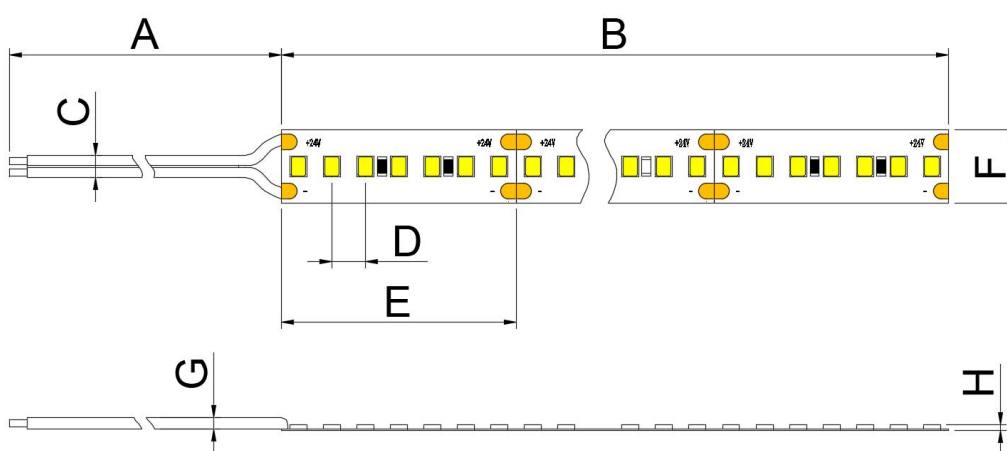

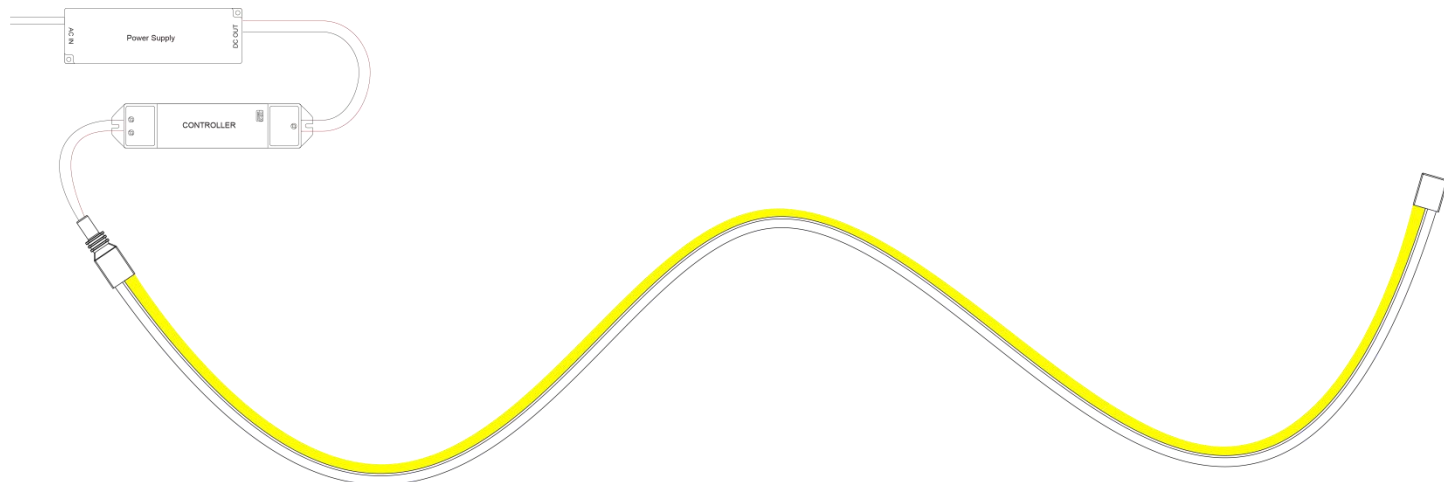

A Cable Length	B Strip length	C Cap width	D Distance of LEDs	E Cutting unit	F Cable diameter	G Cap thickness	H Strip thickness
150±10mm	5000±50mm	4±0.5mm	5.95±0.2mm	41.66±0.2mm	8±0.2mm	2±0.5mm	1.2±0.2mm
5.905±0.39in	196.85±1.97in	0.157±0.019in	0.234±0.007in	1.64±0.007in	0.314±0.007in	0.078±0.019in	0.047±0.007in

Circuit Diagram

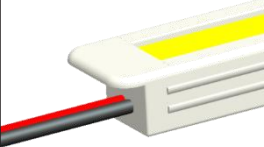
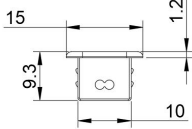

Front & end caps dimensions

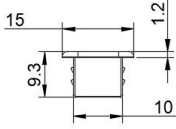
Cable Types	Model No.	Image	Dimension	IP Rating
Double Injection	WW-FLS102T72XX168TC-24(WCP)-UR-1510-TS2-EM WW-FLS102T72XX168TC-24(WCP)-UR-1510-TS2-EM-EP			IP65
				

Optical Parameters

Distribution Curve Flux

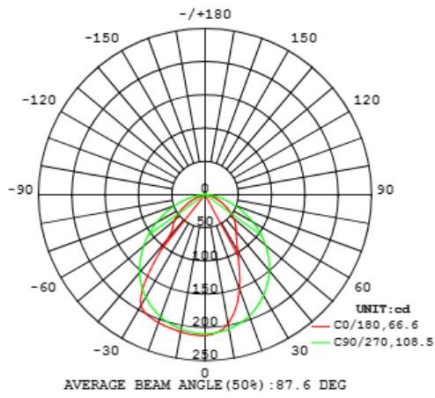

Illuminance

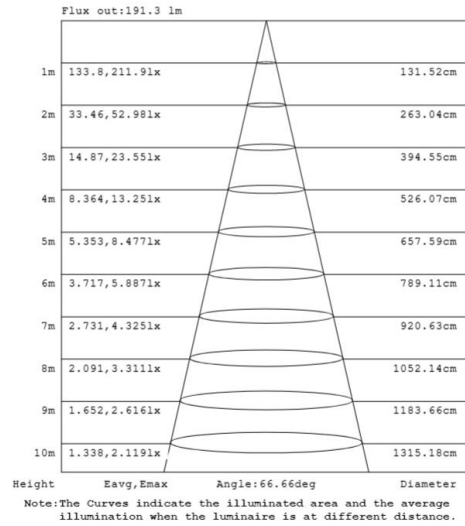

Figures of typical characteristics

Relation of Working Temperature and Power

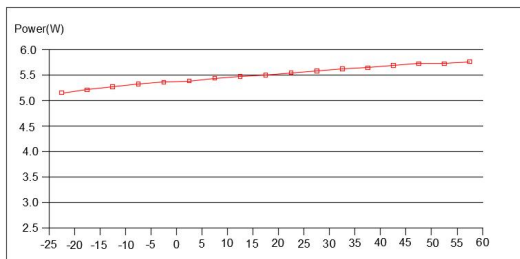

Relation of luminous flux and strip length (Only suitable for white series)

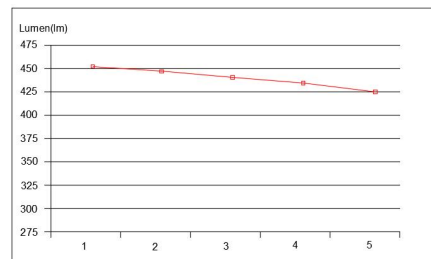

Relation of operating voltage and strip length

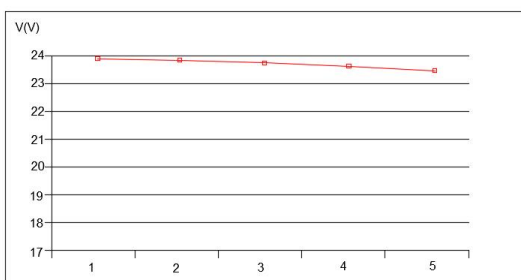

Optional Accessories

Image	Part No.	Description
	WW-FLS102TC- CW(15*10mm)-TT2	Silicon sheet 2PCS Silicone Wire 1PC

Packaging Diagram

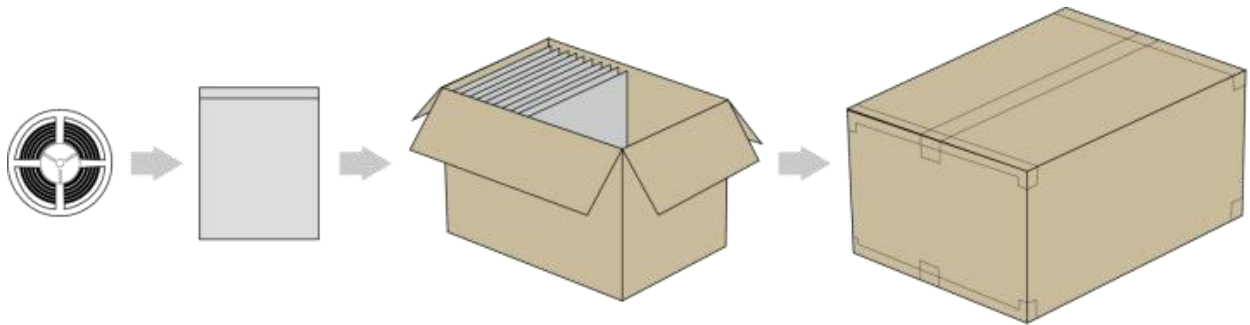

Packaging Information

Ingress protection rating	Bag size	Inner carton		Outer carton		N.W	G.W	Outer carton volume
		Size	Reel/ctn	Size	Reel/ctn			
IP65	350*380*0.14mm	/	/	350*330*330mm	14	6.72KG ±10%	10.68KG ±10%	0.0381m³
	13.78*14.96*0.006 in	/	/	13.78*12.99 *12.99 in	14	14.81 Lbs ±10%	23.54 Lbs ±10%	1.329ft³

Remarks :

- Please contact our sales manager for customized package (color box, blister etc.)

Instruction of Removal Light Source

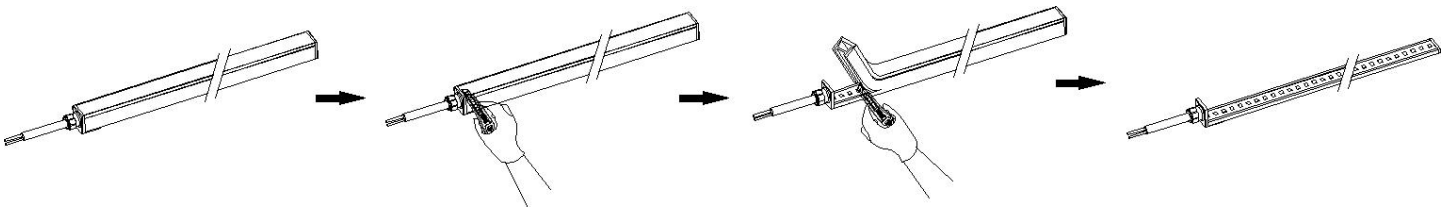

Cutting Instruction

- The cutting line logo on the Neon strip marked by calculated dimension, it has a little bit deviation between internal cutting line marked on the PCB surface;
- Please follow the cutting guidance as below:

Step 1: Fine the cutting line on the silicone coating, slice the silicone coating vertically by knife along the cutting line, but do not hurt the PCB inside.



Step 2: Split the broken silicone coating and observe the deviation between "Cutting line on the PCB" and "Cutting line on the silicone coating side"

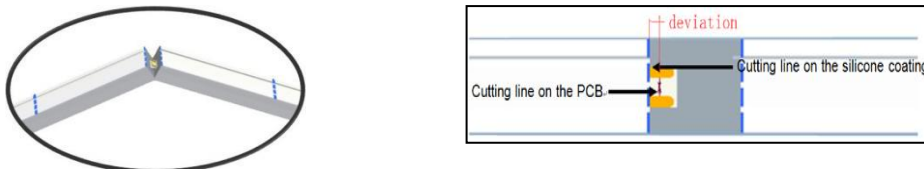

Step 3: Find the cutting line on the PCB, adjust to the exact cutting location and slice the silicone coating again.

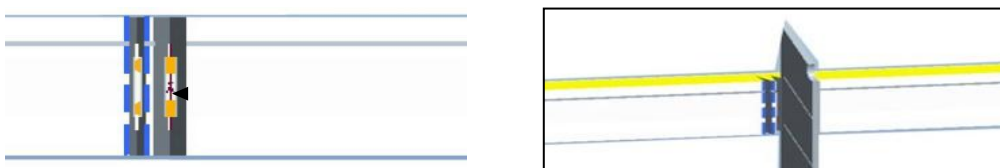

Step 4: Finally, use scissor to separate the Neon Flex along the cutting line on the PCB.

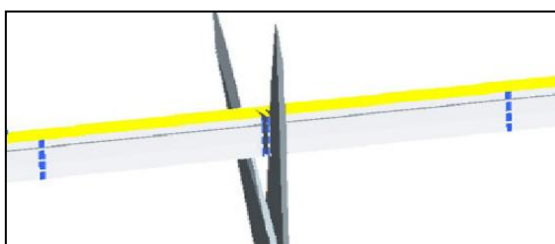

Installation Guidance

1.Embedded installation, slot required, slot width: 10-10.5mm, slot depth: 9-10mm

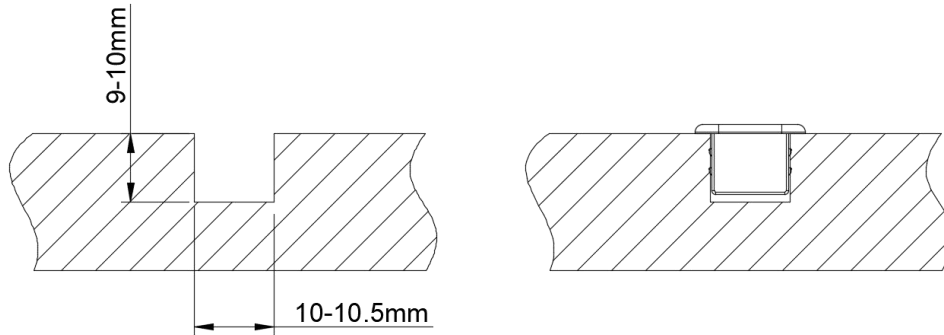

2.Do not bend smaller than allowed minimum bending diameter

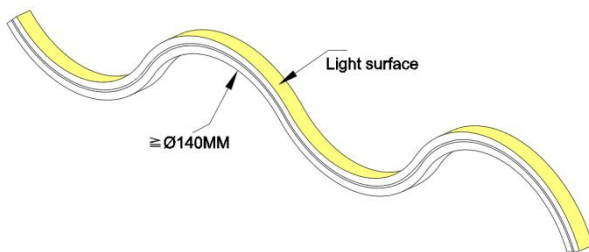

3.The neon strip can only be bent laterally (Along the FPC inside).

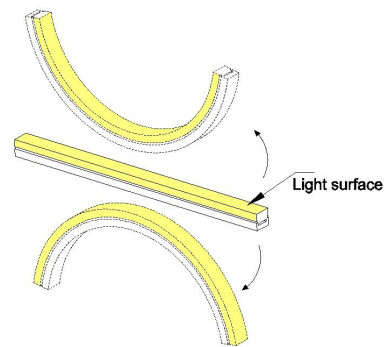

4.Don't bend the LED strip Horizontal , it will damage the circuit inside and cause product function failure.

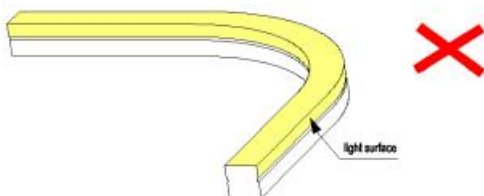

5.Don't twist the LED strip, it will damage the circuit inside and cause product function failure.

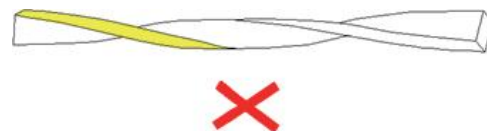

6、 Do not hang or suspend the Neon strip in the air.

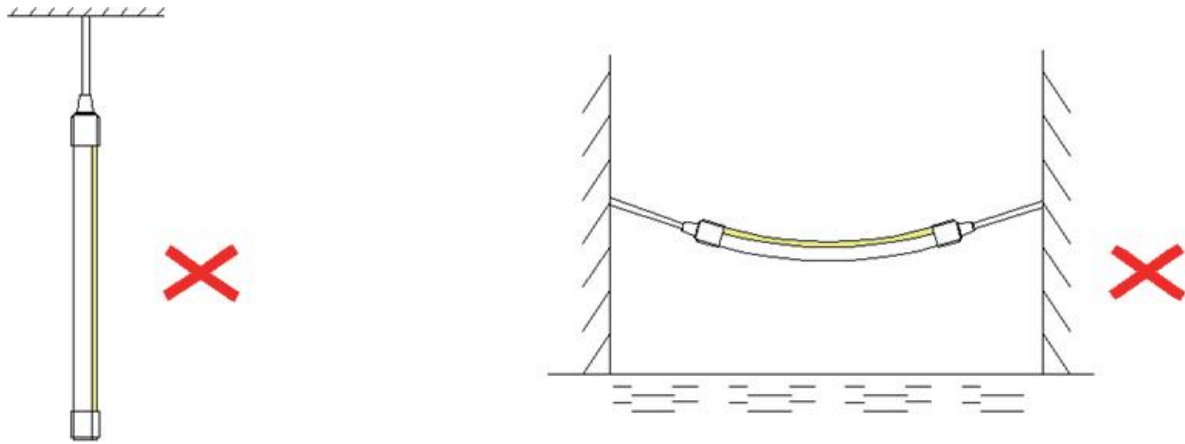











7、 Press the neon flex into mounted aluminum profile in one direction (Angle between strip and aluminum <math>< 15^\circ</math> degrees).



















8、 Incorrect installation like below pictures could lead to product function failure.



 **Cautions**

IP20	IP54	IP65	IP67	IP68
 Do not press the surface of LED	 Pay attention to high temperature environment	 Do not use in strong water waves environment	 Resist strong water waves impact	 Can apply to underwater do not deeper than 1m
 Pay attention to damp proof and dustproof	 Do not apply to rainy environment	 Can be applied to rainy environment	 Do not apply to underwater environment for a long time	 No direct sunlight

 Do not tie a knot	 Do not winding	 Do not twist	 Do not cut when it is working	 Recommended the continuous working time do not exceed 12 hours daily	 Operating temperature -20°C~+45°C (-4°F~+113°F)	 Storage temperature 0°C~+60°C (32°F~+140°F)	 Operated by professionals
 Pay attention to the application environment	 IP Level will change after cutting	 Do not pull and crash	 5M Connected to power supply every 5 meters	 GND Power supply must be connected to ground(GND)	 > 130mm The minimum bending diameter > 130mm	 Power supply retain > 20%	 Note the positive and negative poles



For cutting LED strip operation, it is necessary to use the standard accessories provided by Dilux (e.g. DC wire, end-cap, front-cap, adhesive, etc.), and according to the correct cutting and connecting method for the installation.



For avoiding LED get vulcanized, LED strip should be installed in the environment where does not has oil and corrosive substances. Such as these substances which contain Sulphur, Bromine, Iodine and Chlorine. Some other chemical elements which will cause Aromatic hydrocarbons releasing(such as: methylbenzene, xylene, methyl acetoacetate Ethyl acetate etc.).The environment in which includes strong acid and strong base.



During the warranty period, only defective products are acceptable to be replaced by the factory. Factory is not responsible for other expenses because of replacement, such as transportation fee, installation fee, etc..

**** If you do not follow the above "Cautions" to operate and result in damaging the product, the factory will not accept maintenance and return.**

****The right of final interpretation is owned by Dilux.**