

Product Specification

Neon Flex Horizontal Bending Multi-Color Series (Type TA)

WW-FLS103T50FC098TA-24(WCP)-S-V-1018-XX



HK Office :

Unit 1901, 19th Floor, NanYang Plaza, No. 57 Hung To Road
Kwun Tong, Kowloon, Hong Kong

Tel : (852) 3152 3059 (10 lines)

Fax : (852) 3152 3039

China Factory :

Zhiyang Science and Technology Park, 10 Zhiyang Road, Zhangge,
Fucheng Street, Longhua District, Shenzhen, Guangdong, China

Tel : (86) 755 8601 9190

Fax : (86) 755 8601 9197

Product Features

- High quality FPC
- Dilux self-encapsulated LED
- Light source lifetime:50K hours
- Horizontal bending
- High quality silicone material
- IP67&IP65 waterproof
- Min.Bending Diameter:Φ100mm
- Single-ended power supply maximum length: 5m

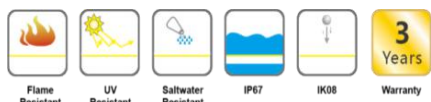

Technology info

- Lighting Technology: LED
- DLS or NDLS: NDLS
- MLS or NMLS: NMLS
- Type of light source: SMD5050
- Energy consumption KW/1000h/0.5M:8.16
- Beam angle : 120°
- Survival factor (Annex V/EU2019-2020) :90%

Harmonised Standards

EMC

- EN55015:2013+A1
- EN61547:2009
- EN60598-1:2015
- EN60598-2-20:2015
- EN62493:2015
- EN62471:2008

Parameters

Test condition:

- Surrounding temperature: 26°C.
- Test while turning on.

Model no.	CRI (Ra)	Rf	Rg	Typ. Power (W/M)	Max. Power (W/M)	Neon Strip Color Temp.	Neon Strip Color Temp. Range**	Typ. Luminous Flux LM / M(39.37in)	Rated voltage
WW-FLS103T50FC098TA-24(WCP)-S-V-1018-XX	/	/	/	16.32	17.95	Red	620-630nm	78	24V
						Green	515-525nm	222	
						Blue	465-475nm	50	

Remark:

- **The above color temperature represents the color temperature range of Neon strip;
- The lumen value tolerance range is $\pm 20\%$ (subject to the manufacturer's instrument test);

Optical Test Diagram

Neon Flex

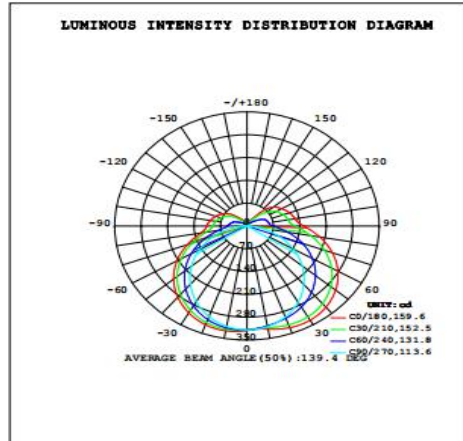
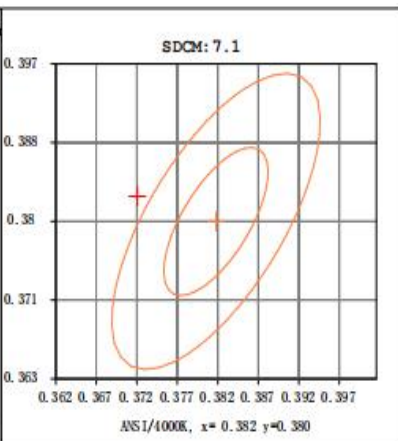
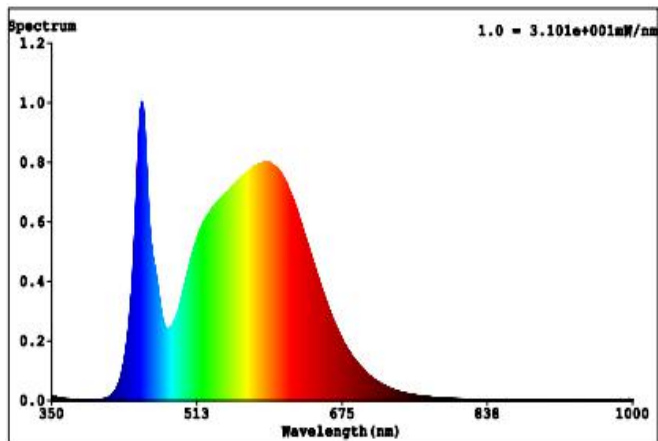

Circuit Diagram

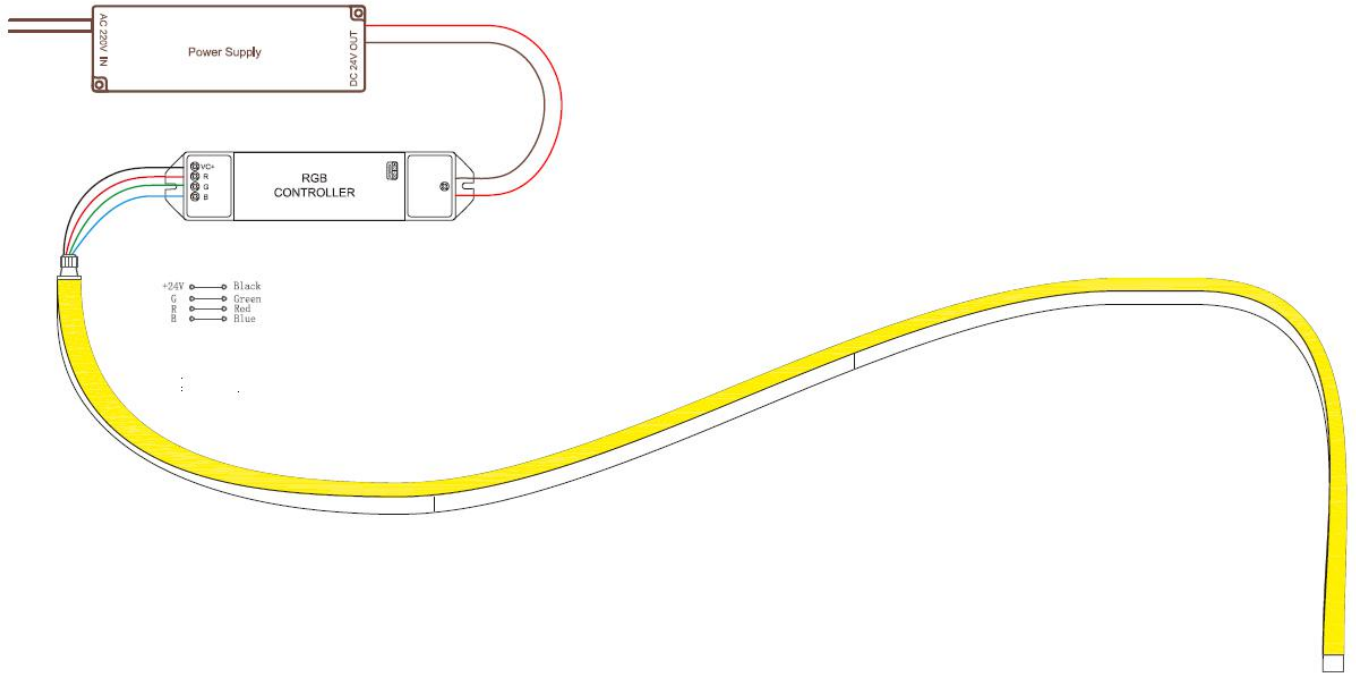



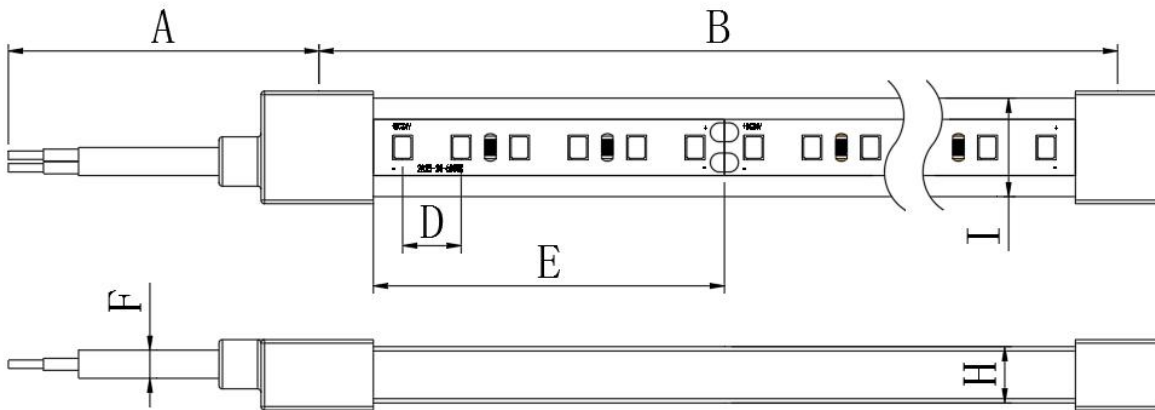



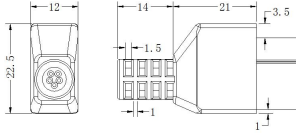

Dimension Drawing

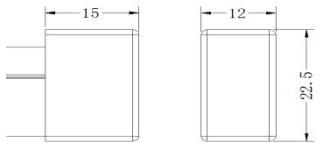

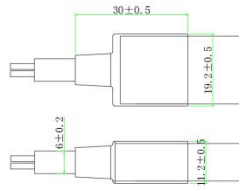
A	B	D	E	F	H	I
Cable Length	Strip length	Distance of LEDs	Cutting unit	Cable diameter	Strip thickness	Strip width
300±10mm	5000±50mm	10.2±0.2mm	71.4±0.2mm	6.0±0.2mm	10±0.5mm	18±0.5mm

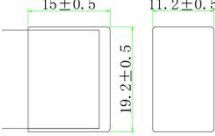
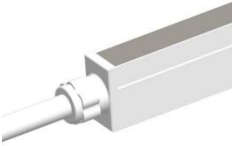
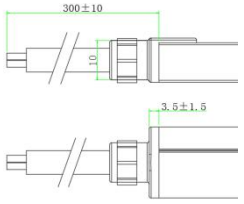
Front & end caps

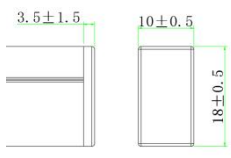
Cable Types	Model No.	Image	Dimension	IP Rating
Double Injection	TA10X18-TS			IP67
				
Same Width	TA10X18-TT2			IP65
				
Double Injection	TA10X18-TS2			IP65
				

Optical Parameters

Distribution Curve Flux

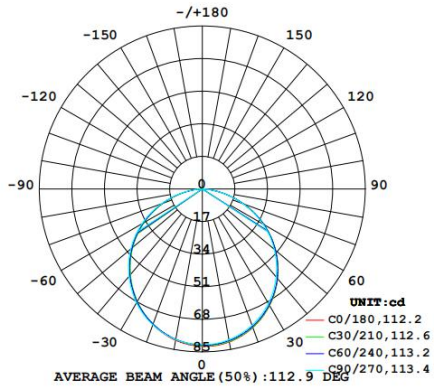

Illuminance

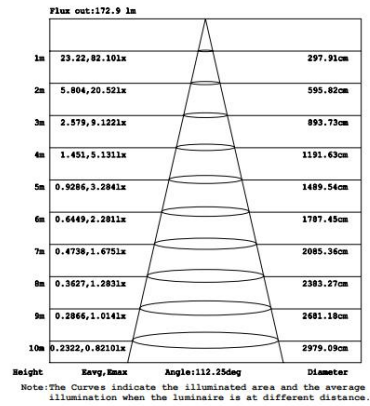

Figures of typical characteristics

Relation of Working Temperature and Power

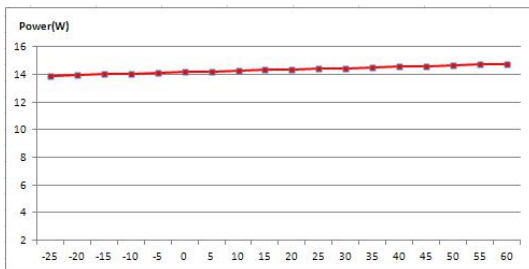

Relation of luminous flux and strip length (Only suitable for white series)

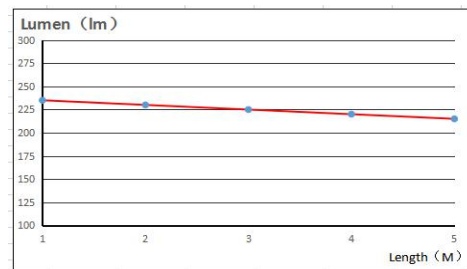

Relation of operating voltage and strip length

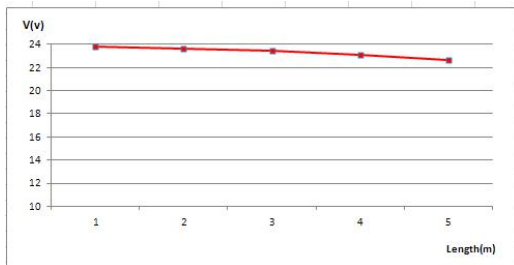

Standard Accessories

Image	Part No.	Description
	<p>WW-T0912-0025(1000S)</p>	<p>Installation accessories set (Stainless steel mounting buckle, screws)</p>

Optional Accessories

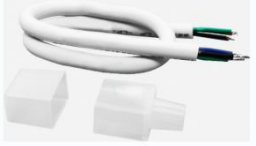
Image	Part No.	Description
	<p>WW-AP1712-200</p>	<p>Aluminum Profile: L2000*W11.6*H17mm</p>
	<p>WW-FLS103TA-CW(10mm)-TT2(RGB)</p>	<p>Cutting accessories set (Front & end cap, power cord)</p>

Packaging

**Solution 1:
For Product Length≤5M**



Ingress protection rating	Bag size	Inner carton		Outer carton		N.W	G.W	Outer carton volume
		Size	Reel/ctn	Size	Reel/ctn			
IP65/IP67	/	/	/	440*400 *260mm	10	10.14 KG ±10%	13.55KG ±10%	0.04576M ³
	/	/	/	17.32*15.748 *10.236 in	10	22.36 Lbs ±10%	29.87Lbs ±10%	1.616ft ³

**Solution 2:
For Product Length=5M**

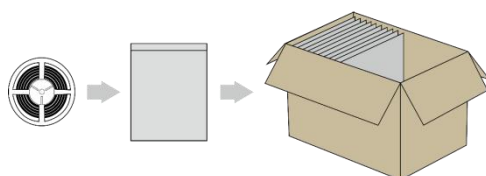

Ingress protection rating	Bag size	Inner carton		Outer carton		N.W	G.W	Outer carton volume
		Size	Reel/ctn	Size	Reel/ctn			
IP65/67	470*420*0.14mm	/	/	440*400 *260mm	7	7.10KG ±10%	10.54KG ±10%	0.0457M ³
	18.50*16.53*0.005in	/	/	17.32*15.75 *10.236 in	7	15.65 Lbs ±10%	23.23 Lbs ±10%	1.616ft ³

**Solution 3:
For Product Length=10M**

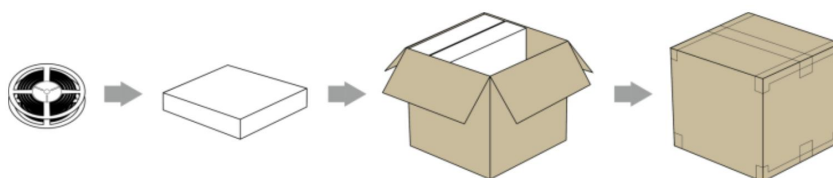

Ingress protection rating	Bag size	Inner carton		Outer carton		N.W	G.W	Outer carton volume
		Size	Reel/ctn	Size	Reel/ctn			
IP65/IP67	330*50mm	345*330*61mm	1	362*265*350mm	4	8.11KG ±10%	12.04KG ±10%	0.0335m ³
	12.99*1.96in	13.58*12.99*2.4in	1	14.25*10.43*13.77in	4	17.88Lbs ±10%	26.55Lbs ±10%	1.185ft ³

For Product Length=20M

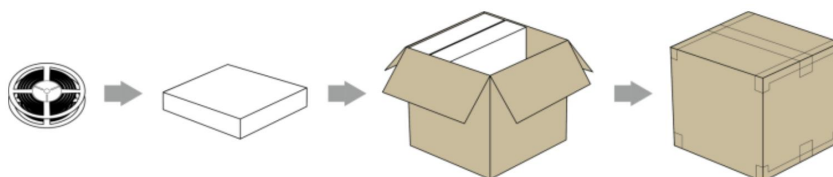

Ingress protection rating	Bag size	Inner carton		Outer carton		N.W	G.W	Outer carton volume
		Size	Reel/ctn	Size	Reel/ctn			
IP65/IP67	330*50mm	345*330*122mm	1	362*265*350mm	2	7.70KG ±10%	11.43KG ±10%	0.0335m ³
	12.99*1.96in	13.58*12.99*4.8in	1	14.25*10.43*13.77in	2	16.98Lbs ±10%	25.21Lbs ±10%	1.185ft ³

Remarks :

- Please contact our sales manager for customized package (color box, blister etc.)

Instruction of Removal Light Source

1. Do not bend smaller than allowed minimum bending diameter

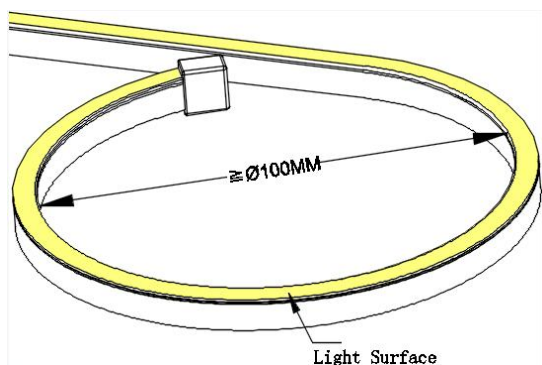

2. The neon strip can only be bent laterally (Along the FPC inside).

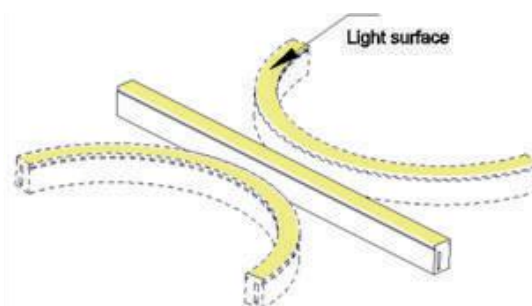

3. Don't bend the LED strip vertically, it will damage the circuit inside and cause product function failure.

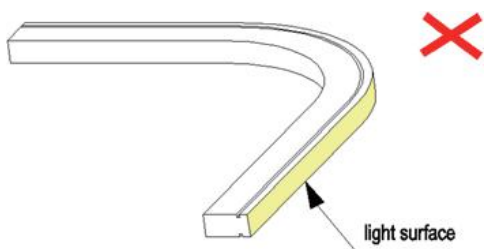

4. Don't twist the LED strip, it will damage the circuit inside and cause product function failure.

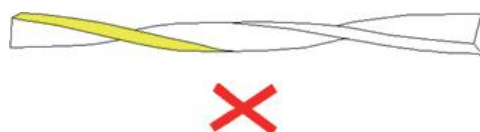

5. Do not hang or suspend the Neon strip in the air.

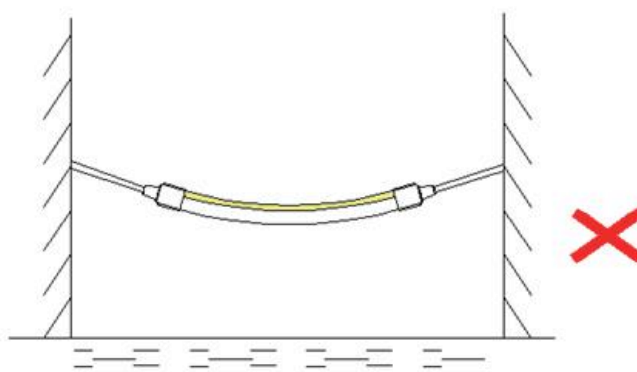
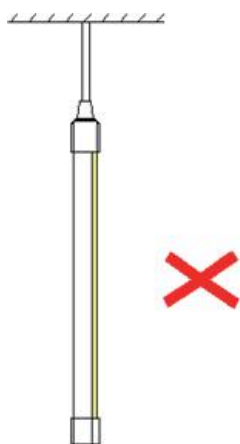

6. Press the neon flex into mounted aluminum profile in one direction (Angle between strip and aluminum <math><15^\circ</math> degrees).



7. Incorrect installation like below pictures could lead to product function failure.



Cutting Instruction

- The cutting line logo on the Neon strip marked by calculated dimension, it has a little bit deviation between internal cutting line marked on the PCB surface;
- Please follow the cutting guidance as below:

Step 1: Fine the cutting line on the silicone coating, slice the silicone coating vertically by knife along the cutting line, but do not hurt the PCB inside.

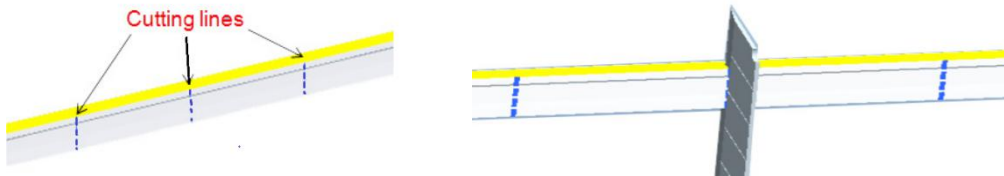

Step 2: Split the broken silicone coating and observe the deviation between "Cutting line on the PCB" and "Cutting line on the silicone coating side"

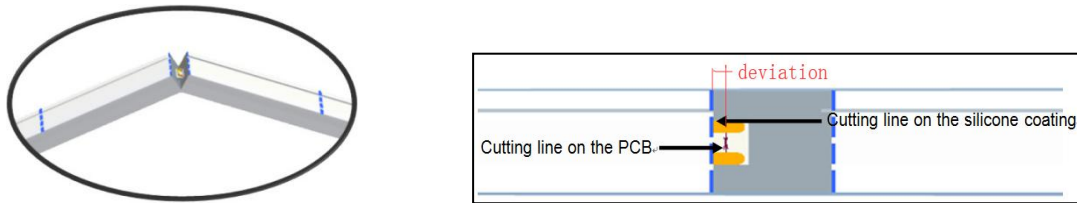



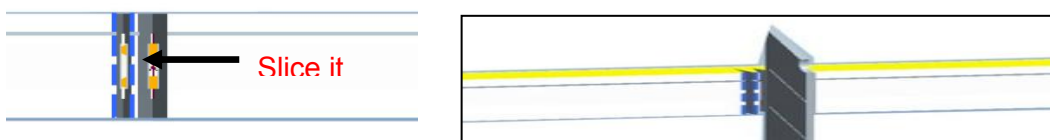



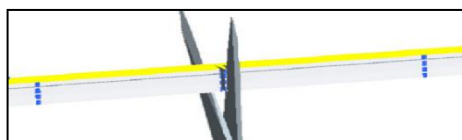



Step 3: Find the cutting line on the PCB, adjust to the exact cutting location and slice the silicone coating again.











Step 4: Finally, use scissor to separate the Neon Flex along the cutting line on the PC





 **Cautions**

IP20	IP54	IP65	IP67	IP68
 Do not press the surface of LED	 Pay attention to high temperature environment	 Do not use in strong water waves environment	 Resist strong water waves impact	 Can apply to underwater do not deeper than 1m
 Pay attention to damp-proof and dustproof	 Do not apply to rainy environment	 Can be applied to rainy environment	 Do not apply to underwater environment for a long time	 No direct sunlight

 Do not tie a knot	 Do not winding	 Do not twist	 Do not cut when it is working	 Recommended the continuous working time do not exceed 12 hours daily	 Operating temperature -40°~+65° (-40°F~+149°F)	 Storage temperature 0°C~+60°C (32°F~+140°F)	 Operated by professionals
 Pay attention to the application environment	 IP Level will change after cutting	 Do not pull and crash	 Connected to power supply every 5 meters	 Power supply must be connected to ground(GND)	 The minimum bending diameter > 60mm	 Power supply retain > 20%	 Note the positive and negative poles

 For cutting LED strip operation, it is necessary to use the standard accessories provided by Dilux (e.g. DC wire, end-cap, front-cap, adhesive, etc.), and according to the correct cutting and connecting method for the installation.

 For avoiding LED get vulcanized, LED strip should be installed in the environment where does not has oil and corrosive substances. Such as these substances which contain Sulphur, Bromine, Iodine and Chlorine. Some other chemical elements which will cause Aromatic hydrocarbons releasing(such as: methylbenzene, xylene, methyl acetoacetate Ethyl acetate etc.).The environment in which includes strong acid and strong base.

 During the warranty period, only defective products are acceptable to be replaced by the factory. Factory is not responsible for other expenses because of replacement, such as transportation fee, installation fee, etc..

** If you do not follow the above "Cautions" to operate and result in damaging the product, the factory will not accept maintenance and return.
**The right of final interpretation is owned by Dilux.